

NRG LOGR | SOLAR

USER'S MANUAL

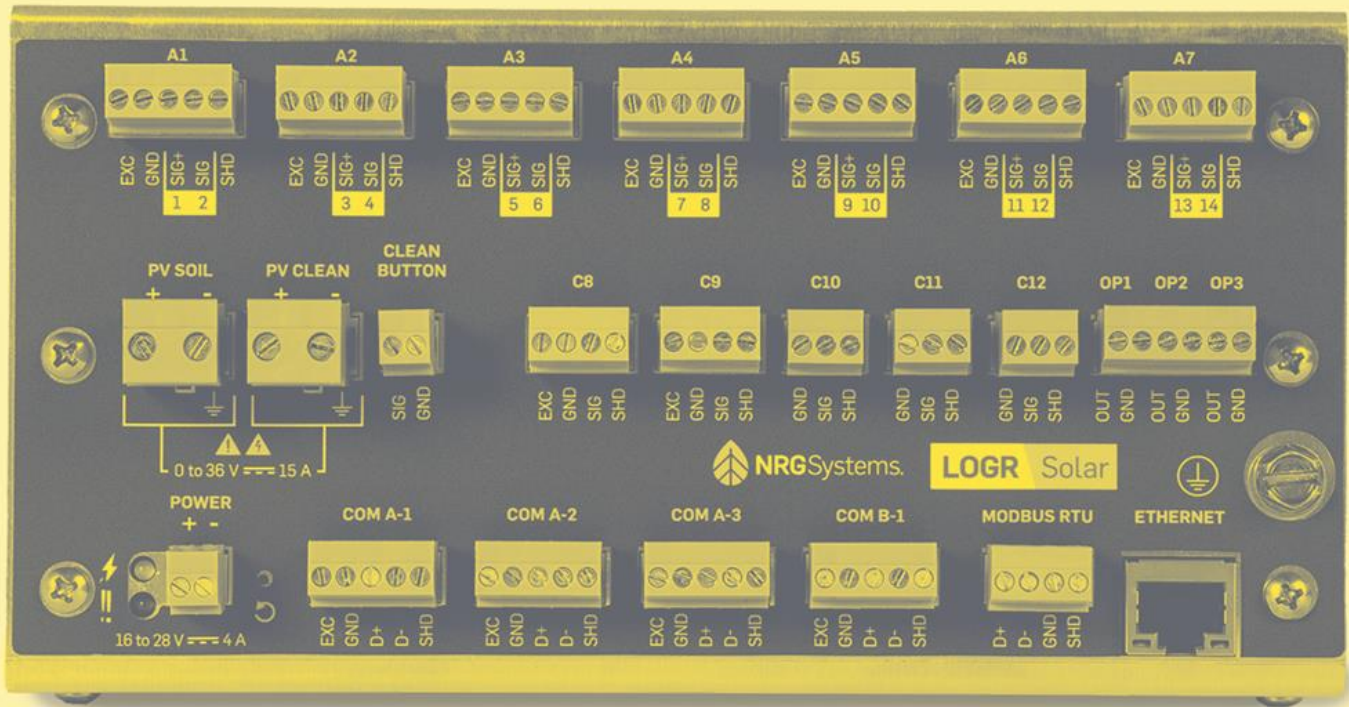

NRGSystems

support@nrgsystems.com

+1 802 482 2255



TABLE OF CONTENTS

SECTION 1 INTRODUCTION	4
About This Manual	4
Typographic Conventions.....	4
Essential Safety Information	5
<i>Safety Considerations / Warnings</i>	5
<i>Maximum Ratings</i>	6
<i>Wire Sizes, Strip Lengths and Torques</i>	6
Quick Start.....	7
Getting Help.....	8
Product Overview	9
<i>Data</i>	11
<i>Communications</i>	11
<i>Concept of Operation</i>	11
<i>Channels</i>	12
Precautions.....	12
<i>Environmental Considerations</i>	12
SECTION 2 SYSTEM OVERVIEW.....	13
Unpacking LOGR.....	13
Components Map.....	13
Power Source.....	15
SECTION 3 PRE-INSTALLATION PREPARATION	16
Connecting via Ethernet.....	16
Network Settings Configuration	17
<i>Configuring the IP Address</i>	17
<i>Modbus RTU</i>	19
<i>NTP Server</i>	20
System Configuration	21
<i>Site Properties</i>	21
<i>Logging Options</i>	22
<i>Power Saving Mode</i>	22
<i>Date and Time</i>	23
<i>System Info</i>	24
Channel Configuration and Data Collection	24
<i>Analog Sensors</i>	24
<i>Analog Measurement Accuracy</i>	24
<i>Analog Channel Configuration</i>	25
<i>Modbus RTU Serial Sensors</i>	28
<i>Serial Port Configuration</i>	28
<i>Serial Channel Configuration</i>	29
<i>Control Scheme Configuration</i>	32
<i>Force Control Refresh</i>	33
<i>Counter Channel Configuration</i>	34
<i>Calculated Channels</i>	36
<i>Calculated Channel Configuration</i>	37
<i>PV Soiling Configuration</i>	39
Pulsed Soiling Module Configuration	43
Sensor Configuration Reset.....	44
Changing LOGR Username and Password.....	45
Data Storage	46
Firmware Updates.....	47
FTP	49



<i>Command Files</i>	49
<i>Command File Options</i>	50
Diagnostics	52
<i>Control Diagnostics</i>	52
<i>Analog Diagnostics</i>	53
<i>Excitation Status</i>	53
<i>Counter Diagnostics</i>	54
<i>Modbus Registers</i>	55
SECTION 4 FIELD INSTALLATION	57
Grounding & Lightning Considerations	57
Mounting	58
Required Tools	59
Sensor Connections	59
<i>Routing Sensor Cables into the Shelter Box</i>	59
<i>Connecting Sensor Wires to LOGR</i>	60
<i>Connecting Soiling PV Panels to LOGR</i>	61
Solar Maintenance Button	62
<i>Installation and Logger Configuration</i>	62
Connecting Relays to LOGR	64
<i>Configuring Output Controls</i>	65
Sensor Wiring Map	66
Logger Data Acquisition	71
<i>Data File Transfer via FTP</i>	71
<i>File Types</i>	73
<i>File Transfer Schedule</i>	73
<i>File Export</i>	74
SECTION 5 COMMUNICATION & DATA	75
Modbus	75
<i>Network & Data Flow</i>	75
<i>Modbus Demo Client</i>	76
SECTION 6 POWER SYSTEMS	82
Powering the LOGR Logger	82
Powering Sensors	82
Grid-Tied Power Systems	82
Autonomous Power Systems	82
APPENDIX A TECHNICAL SPECIFICATIONS	83
APPENDIX B MODBUS MAP	85
APPENDIX C DECLARATIONS OF CONFORMITY	104
APPENDIX D WARRANTY	104
Sending Items for Repair	105
APPENDIX E REFERENCES	106



SECTION 1 | INTRODUCTION

About This Manual

This manual is organized to provide a system overview followed by more detailed configuration and installation instructions.

Typographic Conventions

This font style is used for the general body of this manual.

Instructions in **bold** type direct an action to perform on an operation screen.

This style is used to warn users of a potential danger, either to themselves or to the equipment/data.

Note- This style is used to indicate a tip or an important note.



This symbol indicates information that is critical to understanding the operation of the equipment and/or actions that could damage the equipment without endangering the user.



This symbol indicates a hazard to the user, the equipment, or both that could result in significant injury or damage.



This symbol indicates an electrical hazard to the user.



This symbol indicates a hot surface hazard to the user, the equipment, or both.



This symbol indicates an ESD hazard to sensitive equipment.



Essential Safety Information

Safety Considerations / Warnings

<p>WARNING:</p>	<p>Observe safety precautions: Failure to observe precautions may result in bodily injury and/or damage to the product or interconnected equipment.</p>
<p>WARNING:</p>	<p>Inspect before using: Inspect the equipment and note any damage or defects, including in wiring. Do not use the equipment if damaged or defective.</p>
<p>WARNING:</p>	<p>Qualified personnel only: The product should only be installed and serviced by trained and qualified personnel.</p>
<p>WARNING:</p>	<p>Do not open the enclosure: There are no user-serviceable parts inside the product enclosure. Do not open it. Opening the enclosure may damage the product and/or interconnected equipment and risks bodily injury.</p>
<p>WARNING:</p>	<p>Follow standard safety rules: Follow all other standard safety rules for your PV array installation, in addition to the specific precautions listed here.</p>
<p>WARNING:</p>	<p>PV SOIL and PV CLEAN ports are for connection of solar panels to be monitored for soiling. Some compatible PV panels produce hazardous voltages. Use caution when connecting or handling the PV SOIL and PV CLEAN connections to prevent electrical shock. Use extra care when making these connections to avoid exposed wire or stray wire strands.</p> <p>The logger can measure short circuit currents to maximum 15 A. Do not connect panels with higher short circuit current capability.</p> <p>The Negative (–) terminals of the PV SOIL and PV CLEAN ports are internally connected to the protective earth terminal. Do not connect sources that apply voltages above earth potential to these terminals.</p> <p>Positive (+) terminal to Negative (–) terminal 36 V $\overline{\text{---}}$ maximum.</p>
<p>WARNING:</p>	<p>The POWER input port is rated for 16 to 28 V $\overline{\text{---}}$ only. Application of AC power directly to this port may cause an electrical shock hazard and damage to the product may occur. Do not exceed the 28 V maximum rating. LOGR Solar may draw up to 4 A of current to power itself and the attached sensors.</p>
	<p>The protective earth terminal labelled with this symbol must be connected to a suitable earth ground to provide continued protection from electrical hazards. This ground connection also provides the functional earth connection to provide robust protection of the product against overvoltage and electrostatic discharge.</p>
	<p>LOGR contains a coin cell battery. Do not store it at elevated temperatures (above 85°C). Do not immerse in water. Do not dispose of LOGR in fire. Coin cells may leak or explode. If LOGR is disassembled for disposal, wear PPE. In case of electrolyte leakage from the battery, take up with an absorbent cloth. Treat cloth as flammable.</p> <p>Perchlorate Material – special handling may apply.</p>



Maximum Ratings

CLEAN BUTTON	Intended to read a dry contact only. Do not apply external power to this port.	+ to – Input 3.3 V == 1 mA
ANALOG SENSOR INPUT Ports A1 to A7	EXC terminal is an output, providing excitation power to the attached sensor.	EXC Output to GND 12.3 V == maximum power 50 mA SIG+ or SIG- Inputs to GND +/- 12 V ==
COUNTER SENSOR INPUT Ports C8 to C12	EXC terminal is an output, providing excitation power to the attached sensor.	Output to GND 12.4 V == maximum power 50 mA SIG to GND 15 V == max
OUTPUTS Ports OP1 to OP3	To supply power to connected sensors.	OUT to GND 12.4 V == maximum power 500 mA
COM A and B Ports	EXC terminal is an output, providing excitation power to the attached sensor.	EXC Output to GND 12.4 V == maximum power 1 A D+ or D- to GND: 5 V == max
MODBUS RTU Port	Remote terminal unit communication port.	D+ or D- to GND: 5 V == max

Wire Sizes, Strip Lengths and Torques

ANALOG, COUNTER, OUTPUT, MODBUS RTU, COM, CLEAN BUTTON, POWER ports	<p>Wire Size: 28 AWG to 14 AWG (0.2 mm² to 1.5 mm²)</p> <p>Strip length: 6 to 7 mm (0.24 to 0.28 inch)</p> <p>Torque: 0.2 N·m (1.8 inch-pounds)</p> <p>Tool: Use slotted screwdriver (blade thickness x width) 0.4 mm x 2.5 mm (0.016 x 0.10 inch)</p>
PV SOIL and PV CLEAN ports	<p>Wire Size: 24 AWG to 12 AWG (0.2 mm² to 2.5 mm²)</p> <p>Insulation: Rated for at least 60 V == 15A</p> <p>Strip Length: 7 to 8 mm (0.28 to 0.31 inch)</p> <p>Torque: 0.5 N·m (4.4 inch-pounds)</p> <p>Tool: Use slotted screwdriver (blade thickness x width) 0.6 mm x 3.5 mm (0.024 x 0.14 inch)</p>



Quick Start

The basic steps necessary to start receiving data from a LOGR system are as follows:

1. Physical connection:
 - 16 to 28 VDC power supply (4 A max) to power terminals (see [Power Source](#) and [Power Systems](#))
 - Ethernet cable from computing device to LOGR Ethernet port (see [Connecting via Ethernet](#))
2. Open a web browser and connect to the LOGR default IP Address via URL: **http://192.168.1.110**
3. Configure FTP Server (optional feature, see [FTP](#) and [Data File Transfer](#))
4. Update LOGR firmware if indicated (see [Firmware](#))
5. Configure:
 - Static IP Address (Logger > Network Settings)
 - Site name, project name, location details (Logger > System Configuration)
 - Time Zone setting (Logger > System Configuration)
 - NTP server (Logger > Time Synchronization, optional)
 - Channels for connecting sensors with the system (Sensors menu)
6. Save



Getting Help

NRG Systems offers a variety of support options to help you get the most from your NRG product. If you have questions about your NRG product, first look at the product documentation on the NRG website. ([NRG Systems LOGR | Solar Data Logger](#)).

If you cannot find the answer, contact your salesperson or NRG Systems Technical Support for assistance using the information below. Customer support is available 8:30 AM to 5:00 PM ET, Monday through Friday.

Telephone: +1 802-482-2255 ext. 3

Fax: +1 802-482-2272

Email: support@nrgsystems.com

When you call or email, please have the appropriate product documentation and the following information:

- Customer name
- Equipment purchaser
- Item number or description
- Serial number(s)
- When equipment was purchased
- Where equipment is installed including terrain and climatic conditions
- Description of the problem with some detail
- What events took place leading up to the problem
- What you have tried while attempting to solve the problem

You may be asked to provide data files or logs to help us investigate an issue. All information and data provided are kept strictly confidential.

NRG Systems maintains an extensive website which includes an in-depth customer support area. If you need assistance at times outside of regular business hours, we suggest visiting our website, www.nrgsystems.com.

All instruments, sensors, software, and towers manufactured by NRG Systems are designed to be reliable and easy to use. We welcome your comments and appreciate your help in making our products the best available.



Product Overview

Designed specifically for the renewable energy industry, the NRG LOGR-S Data Logger (item 9431, introduced September 2021) is a versatile, high-utility data logger and real-time sensor interface designed for post-construction solar resource monitoring applications (e.g., performance monitoring and forecasting).

The LOGR | Solar model 9432 (henceforth known as “LOGR” in this document) introduced in the fall of 2023 replaces the original model 9431. The updated version enables more sensor flexibility and management of meteorological stations for solar monitoring in the way of counter inputs and control voltage outputs.

Powered by 16 to 28 VDC, this compact DIN rail-mountable logger is compatible with a wide range of industry-standard (Modbus RTU and analog) sensors, with onboard dedicated PV soiling inputs supporting PV soiling studies.

Configuration is performed via wired network connection through the LOGR’s Ethernet port and by using the internal web browser interface. This allows the user to manage channel configurations, update firmware, and check basic logger functionality. No proprietary configuration software is required, and a Modbus client utility is provided to test final configurations.

Data is acquired once per second and averaged into 1-minute intervals; intervals are time stamped with the beginning time of each interval. A comprehensive Modbus register set provides users easy access via Modbus TCP or RTU.

To backfill SCADA systems, internal storage holds up to 90 days of 1-second data collection or 365 days if 1-second data recording is disabled. The onboard FTP client moves ASCII data files from the logger onto a user specified FTP server via the Local Area Network, allowing SCADA operators to continuously gather and collect backup data. The user can also load configuration “command” data onto the FTP server, which the LOGR will retrieve and apply (firmware updates, logger, sensor, and channel configurations, and data file export).

The comprehensive analog sensor section is capable of up to 7 differential or 14 single-ended measurements (or a combination thereof) and provides 12 V sensor excitation ports as well as current source excitation for RTDs and thermistors. Also included is built-in surge and ESD protection, tested to IEC 61000-4-5 for surge immunity.

The serial sensor section can support up to 12 Modbus RTU sensors and up to 24 measurands in total. Data collection via Modbus registers is available for both one second and statistical (average, max, min, and standard deviation) measurements.

The counter section can support up to five anemometers and tipping bucket rain gauges.

The control section contains three switched 12.4 V output signals suitable for driving relays controlling external pyranometer heaters, and other devices.



The PV Soiling section is capable of performing pulsed short-circuit (Isc) and open-circuit voltage (Voc) measurements on crystalline PV panels up to 36 Voc and 15 A Isc. The logger conforms to IEC 61724-1 when utilizing the external [Pulsed Soiling Module](#).

Labeled terminal ports with removeable connectors facilitate error-free installations and maintenance. Also provided are blank labels enabling the user to create custom tags for terminal ports. Use of a fine-point permanent marker is recommended when writing on blank labels.

For quality traceability, a factory acceptance test report is available for each individual logger.



Data

LOGR data acquisition provides for:

- 1 Hz sampling rate
- Statistical data, processed at 1-minute intervals
- Internal data storage via embedded 8 GB microSD card
- FTP Client
- Direct data file download

Communications

- Ethernet port to access built-in webserver and Modbus data retrieval

Concept of Operation

LOGR requires a TCP/IP network infrastructure support to operate as a sensor-to-SCADA interface:

- Modbus Client (SCADA system to poll LOGR)
- Web Browser (for configuration of LOGR, e.g., Google Chrome)

Optionally, the LOGR utilizes:

- Network accessible FTP Server (LOGR will deposit data/diagnostic/event log files if needed for backup purposes)
- Network accessible FTP Client (for Administration of LOGR, such downloading/uploading unit or sensor configurations)
- Network accessible NTP Server (LOGR will time synchronize once daily if an accessible NTP server is provided)

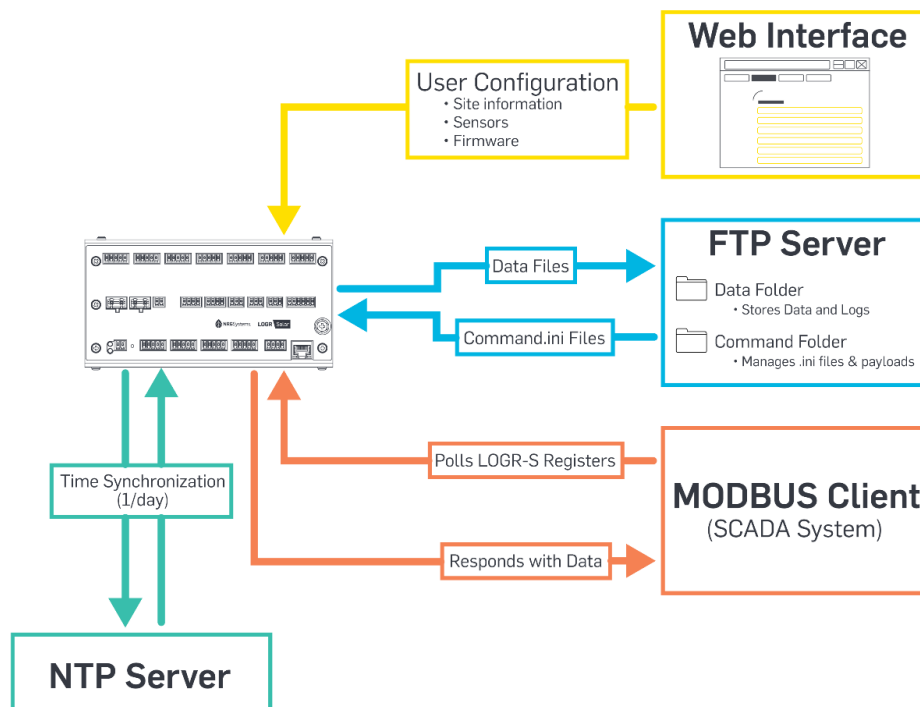



Channels

Below is a summary of available measurement channels on LOGR | Solar (item 9432):

Channel Type	Channel Count (Capacity)	Channel Number Range
Analog*	14	1 to 14
Serial	24	101 to 124
PV Soiling Ratio	5	201 to 205
Calculated	10	301 to 310
Counter	5	401 to 405

**Each removeable terminal block in the Analog section can accommodate up to two single-ended measurement sensors or one differential sensor, but not both.*

Precautions



Failure to adequately ground the system puts the logger and sensors at risk for electrostatic damage (ESD). The included grounding cable should be affixed to Earth ground to provide a discharge path from the logger to earth.

Care should be taken to avoid ground loops in the system when planning installation.



When operating in higher ambient temperatures, the outer surface of the logger may become hot to the touch.

Users should test or measure the temperature of the logger before touching or handling it after extended periods of use in warmer climates.

Environmental Considerations

- Sensor cables become less flexible and are more easily damaged at low temperatures. Make sure that all cables are securely fastened so they do not flap in the wind.
- If the equipment will be exposed to high salinity, use protective grease or other dielectric agent on terminals and ground connections.



SECTION 2 | SYSTEM OVERVIEW

This section of the manual is designed to provide basic information needed to prepare and install a LOGR system. See [System Configuration](#) for description and instructions of the web User Interface (UI), and [Field Installation](#) for physical installation and wiring.

Unpacking LOGR

Confirm that all components have been received by comparing the on-hand equipment to the packing list included with the shipment. Immediately contact NRG Systems if any components are missing.

Components Map

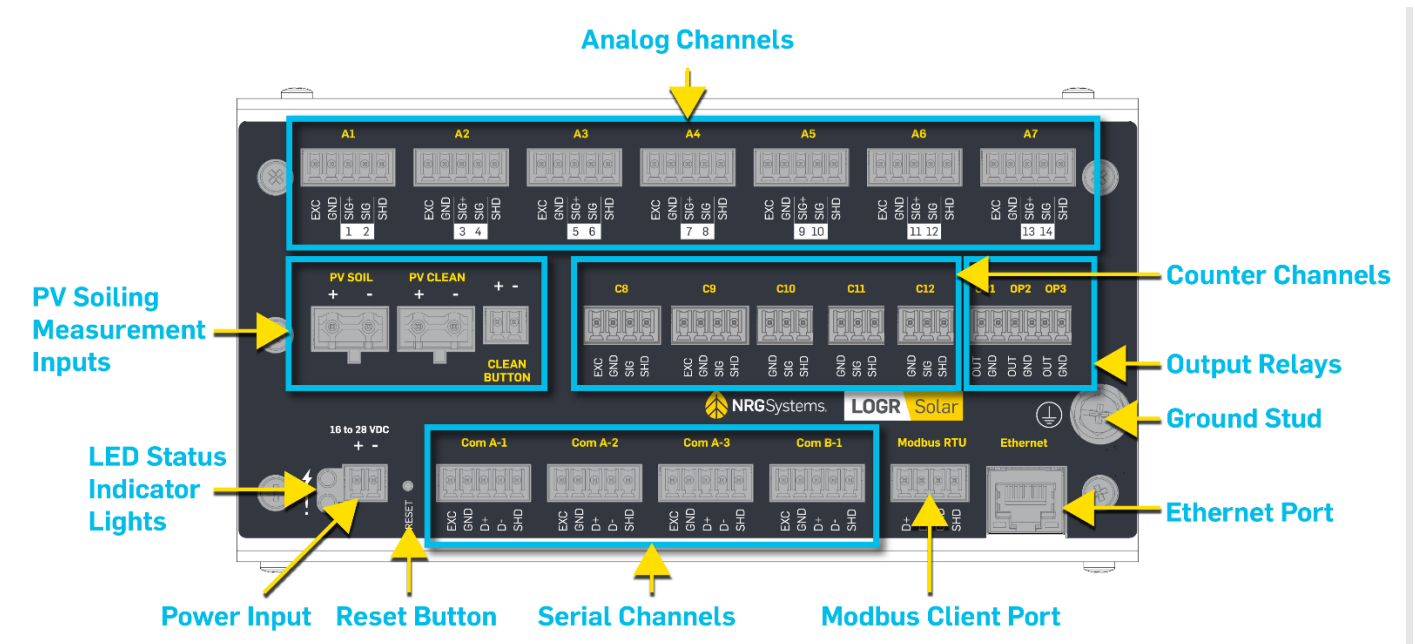



Serial Number and Logger Identification label	<p>Each LOGR can be identified by the label on the top of the case, which contains the model name, serial number (9432XXXXX) and MAC Address.</p> <p>The LOGR Solar (item 9432) introduced fall of 2023 with serial number (943201000)</p>
Analog Channel Ports	<p>Seven ports can support up to fourteen (14) single ended sensors, or up to seven (7) differential sensors.</p>
Serial Channel Ports	<p>Three COM-A and one COM-B serial ports can support up to twelve (12) sensors with programmable baud rates differing between the A and B ports. Twenty-four (24) serial channels are available for measurand configuration.</p>
Counter Channel Ports	<p>Five counter channels support coil, pulsed, open collector anemometer and tipping bucket rain gauge sensors. The first two ports provide 12 V excitation in addition to signal inputs.</p>
Switched Output Ports	<p>Three switched output ports labeled OP1, OP2, OP3 provide 12 V signals capable of driving external relays for controlling accessories such as pyranometer heaters.</p>
PV Soiling Measurement Inputs	<p>These ports are designed to support the NRG Soiling Measurement Kit which delivers a ratio between clean and soiled PV panels. These ports also accept power and ground inputs from other PV panels. Wire gauges accepted are 30 to 12 AWG (0.2 to 2.5 mm²).</p>
LED Status Indicator Lights	<p>Two LEDs, one green (power) and one red (fault), provide immediate user feedback at the logger. A steady green light indicated consistent power and proper function of the LOGR. A blinking red light indicates errors or an in-progress firmware update.</p>
Power Input	<p>LOGR requires 16 to 28 VDC of power input. The logger typically draws 75 mA at 16 V (1.2 W) when unloaded.</p>



Modbus Client Port	This Modbus RTU port allows the LOGR to connect directly with a computer, or to another logger.
Ethernet Port	This ethernet port features a green LED to indicate traffic. The flashing light indicates active data acquisition transfer.
Ground Stud	The #10 grounding stud should be connected to earth ground with either the provided grounding cable or alternative.
Reset Button	The logger ethernet network configuration (IP, Net Mask, Gateway, DNS) can be reset to factory default by inserting a paper clip to depress the recessed button. All other configurations will remain programmed.

Power Source

LOGR requires a DC power supply of 16 to 28 VDC and consumes up to 4 A of current at 16 V when supplying power to attached smart sensors. Nominal supply voltage is 16 V, and the unit contains no boost regulators. At 28 V this logger consumes 2.3 A.

If the voltage decreases below 16 V, the unit still functions but **Modbus and analog sensor excitation ports follow the input voltage down**. When the input voltage gets dangerously low and data can no longer be reliably acquired and recorded, the unit will shut down so that all internal settings are protected.



SECTION 3 | PRE-INSTALLATION PREPARATION

While LOGR is easy to set up, it is prudent to become familiar with the system before going to the installation site. The following sections provide an overview of the software used to prepare a LOGR system for field installation. Relevant operational details are provided to help optimize the system and its communications for a specific site and project.

Connecting via Ethernet

Once LOGR is powered, it performs a starting sequence and will emit a beep when ready for configuration. Connect to LOGR through the Ethernet port with a standard Cat 5 or Cat 6 cable to a device running a web browser.

The **LOGR default IP Address is 192.168.1.110, Subnet mask 255.255.255.0.**

Using a desktop or laptop computer, open a web browser and type **http://192.168.1.110** into the URL address bar. If the device is unable to reach the LOGR default IP address, check that the device is on a compatible IP and subnet mask as above. Change network adapter settings as needed; this will require administrator credentials for your device.

A window will open prompting a username and password. The default security credentials are as follows:

Username: admin

Password: logradmin



Network Settings Configuration

Configuring the IP Address

LOGR can be set to use DHCP for use on a network containing a DHCP server or use a static IP address (default option). To set the IP address, navigate to the Logger Menu at the top of the window and select **Network Settings** from the drop-down options.

Ethernet Settings

Obtain IP Address Automatically
 Enabled Disabled

IP Address
195 168 155 220

Net Mask Address
255 255 240 0

Gateway Address
195 168 155 8

DNS Address
195 168 155 55

Cancel Apply

Decide whether to obtain an IP address and related settings automatically (use DHCP) or to enter them manually.
If DHCP is disabled, enter the desired network address configuration above. Press the tab key to advance to the next field. After pressing the 'Apply' button a confirmation screen containing the new configuration will be displayed.
The new configuration will not take effect until confirmed. The confirmation screen will only appear if manually entering the configuration.

Using DHCP – *Obtain IP Address Automatically* | **Enabled**

– *Obtain IP Address Automatically* | **Disabled**

– **Enter values for the fields below: ***

Using Static IP address

- IP Address*
- Net Mask Address*
- Gateway Address*
- DNS Address*

*These fields are only editable when *Obtain IP Address Automatically* is disabled.



When completed select the yellow **Apply** button, then confirm values are correct and select the **Confirm** button on the resulting Network Address Confirmation screen.

LOGR takes about 10 seconds to confirm the settings change and will emit a beep when complete. The home page address becomes X.X.X.X/index.htm, where X.X.X.X is the newly specified IP Address. A new web browser tab will open and redirect automatically with the updated network information. The original browser tab will remain open until closed.

If a connection cannot be secured and a static IP address has not been set, *the LOGR defaults to IP Address 192.168.1.110, subnet 255.255.255.0.*



*If a link is still not made, the LOGR can be reset to the default IP address by pushing and holding the **RESET** button on the logger face until a beep is heard. The reset button is located **between** the **16 to 28 VDC** input and the **COM A-1** serial channel block.*

If set to use DHCP and obtain a web address automatically, and a DHCP server is not found, LOGR **defaults to IP Address 192.168.1.110.**

Once configured, LOGR should be connected to a SCADA network where real-time data is available via Modbus TCP and is viewable on the webserver **Sensor Outputs** home page.



*For any single LOGR unit only **ONE** user may be logged into the webserver at any given time. If two browsers are open and connected to the same LOGR IP address, full functionality will not be available and saving edits and configurations may be hindered.*



Modbus RTU

LOGR has an available Modbus Remote Terminal Unit (RTU) Server Port which enables the logger to be used with a Modbus server to query the registers in the SCADA map. This port mirrors the use of the ethernet port for Modbus with serial communication.

To configure this port:

1. Navigate to the **Logger** menu at the top of the page and select **Network Settings** from the drop-down options.
2. Scroll to the **Modbus RTU Settings** to complete setup.
3. Edit the **Client Address**, **Baud Rate**, **Data Bits**, **Parity**, **Stop Bits** as necessary and choose if the **Termination Resistor** is *Enabled* or *Disabled*.
4. Click the yellow **Save** button to apply changes to the port settings. Note that when these values are saved the LOGR will reboot.

Modbus RTU Settings

Client Address: 1

Baud Rate: 19200

Data Bits: 8

Parity: Even

Stop Bits: 1

Termination Resistor: Enabled Disabled

Save



NTP Server

For improved time accuracy, an NTP server can be configured for daily time updates. The server status and most recent check-in date and time is also presented on this page.

To configure:

1. Navigate to the Logger menu at the top of the page and select **Time Synchronization** from the drop-down options. The LOGR defaults to **Disabled** (no NTP checks).
2. Set the NTP mode to **Local** and enter the IP Address or URL of a preferred local NTP server.
3. Click the yellow **Save & Ping** button. This will check the server and automatically update the *Last NTP Update* date/time.

NTP Configuration

Mode

Local Disabled

Local NTP Server IP / URL

techservtest.nrgsystems.inc

NTP Server Status **Last NTP Update**

NTP Time Adjusted 2022-04-22T13:52:39Z

Cancel Save & Ping



Note that LOGR has an embedded coin cell battery installed to maintain operation of the real-time clock through power disruptions.



System Configuration

Navigate to the **Logger** menu at the top of the page and select **System Configuration** from the drop-down options.

Site Properties

Site	This field contains the name for the site. A site description of up to 32 characters can be entered. This is used to provide a brief description of the site or the site number, such as "Site 1234." Frequently the last four digits of the logger serial number are used as a site number.
Project	This field contains the project name for the site. A project description of up to 20 characters can be entered. Project is usually a broader term that can describe a group of multiple sites. This is used to provide a brief description of the overall project, such as "Windy Solar Farms."
Location	This field contains the location name for the site. A location description of up to 32 characters can be entered. This is used to provide a brief description of the site, such as "Block B Tower" and may include the site number if there are multiple in the same area
Latitude	Enter latitude in decimal degrees (rather than in degrees, minutes, seconds). Entry should be formatted like "44.3286110." Use positive (+) numbers for northern latitudes; use negative (-) numbers for southern latitudes.
Longitude	Enter longitude in decimal degrees (rather than in degrees, minutes, seconds). Entry should be formatted like "-73.1100000." Use positive (+) numbers for eastern longitudes; use negative (-) numbers for western longitudes.
Elevation (m)	Enter the elevation of the installation location in meters.

Site Properties

Site	Project	Location
NRG Systems	Testing Facility	Hinesburg, VT
Latitude	Longitude	Elevation (m)
44.3388939	-73.1120224	136

Save



Logging Options

By checking the **Record 1-second Data** box, the logger will store these large statistical data files for 90 days. If the box is unchecked, the smaller (1-minute averaged data) files allow for 365 days of data storage.

Logging Options

Record 1-second Data (Change of setting requires data clear) ⓘ

Save

Power Saving Mode

Power Saving Mode is enabled to take advantage of automatically lowering power consumption when the LOGR switches to a backup power source. This is achieved by monitoring the mains voltage channel and turning sensor heater loads off to conserve power.

Power Saving Mode

Enable

Power Saving Mode senses when the LOGR is running on a backup power source (by reading the mains voltage monitor channel) and turns off heater loads in order to conserve power.

Save



Date and Time

Device Time (Local Logger)	The LOGR clock's current time is displayed. Verify that this is the current time in the local time zone in standard time (not "daylight-saving" time).
Reference Time (UTC)	Reference Time is the PC clock's current time, displayed in UTC. Pressing the Set Time button will update the logger's clock to the reference time.
Time Zone	Select the LOGR's local time zone from the drop-down list. Note: Use logger local standard time (not daylight-saving time). The logger clock will not adjust for daylight saving time.

Date and Time

Device Time (Local Logger)	Reference Time (UTC)	Time Zone
2021-10-15T17:47:53	2021-10-15T22:47:53Z	UTC-5:00

Set Time



System Info

This section provides the full serial number of the logger as well as information on the installed and configured PC boards.

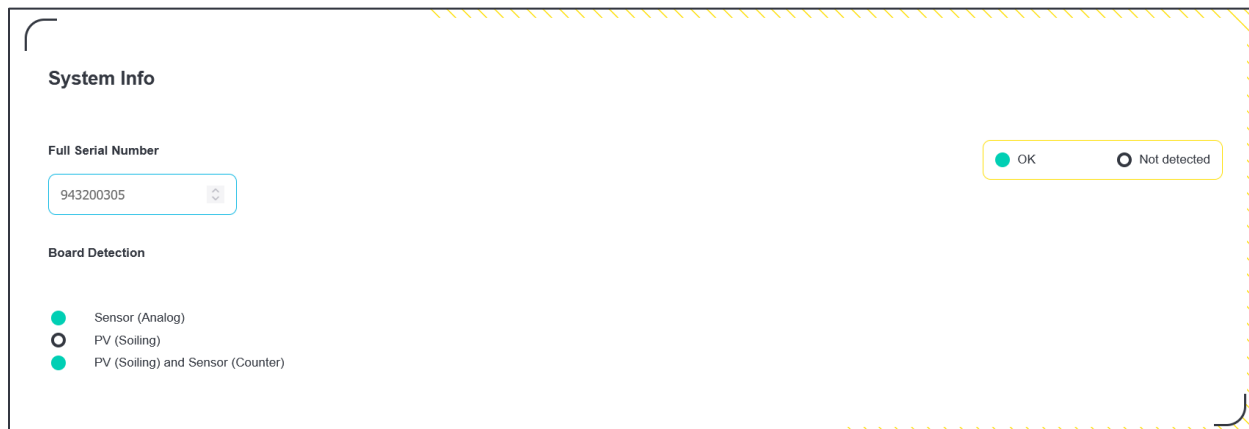

Channel Configuration and Data Collection

Analog Sensors

LOGR provides **seven ports** for a total of **fourteen analog channel options**. These are used for measuring parameters including solar radiation, PV temperature, ambient temperature, barometric pressure, relative humidity, wind direction, and more. The LOGR analog sensor ports have **12 V excitation** with a limit of **50 mA per port**.

Each port can be configured to support two single-ended sensors, each on a separate channel, or one differential sensor. This totals seven differential or fourteen single-ended sensors (or a combination thereof). LOGR has a variety of default sensors available, but generic sensors are also supported by selecting the correct voltage level for the specified sensor. Note that the scale of (-75 to +75) mV is for use with differential sensors only. All other measurement levels can be used for either single ended or differential sensors. For complete analog sensor wiring instructions, see the [Required Tools](#) and [Sensor Connections](#) sections.

Analog Measurement Accuracy

Voltage Level	Uncertainty (k=2)
(-70 to +70) mV	8.5 uV
(-1 to +1) V	61 uV
(-10 to +10) V	450 uV



Both 1-second and statistical (average, max, min, and standard deviation) data are available via Modbus registers. The web server home page provides a quick view of live data to ensure sensors are connected and performing properly during setup.

Analog Channel Configuration

1. Navigate to the **Sensor** menu at the top of the page and select **Analog Channels** from the drop-down options. Select **Configure** next to the desired channel.

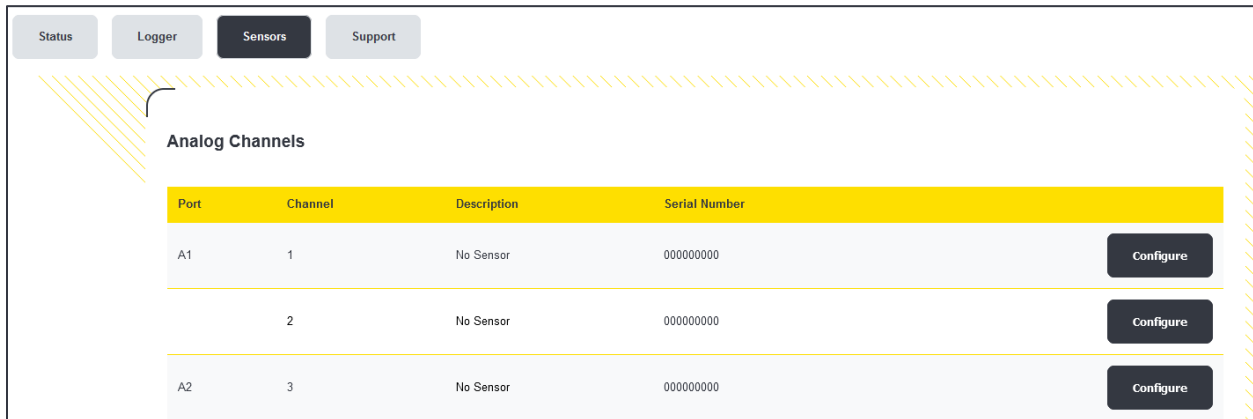

Selecting **Configure** for a specific channel will redirect to the **Analog Channel Configuration** page for the specified channel.

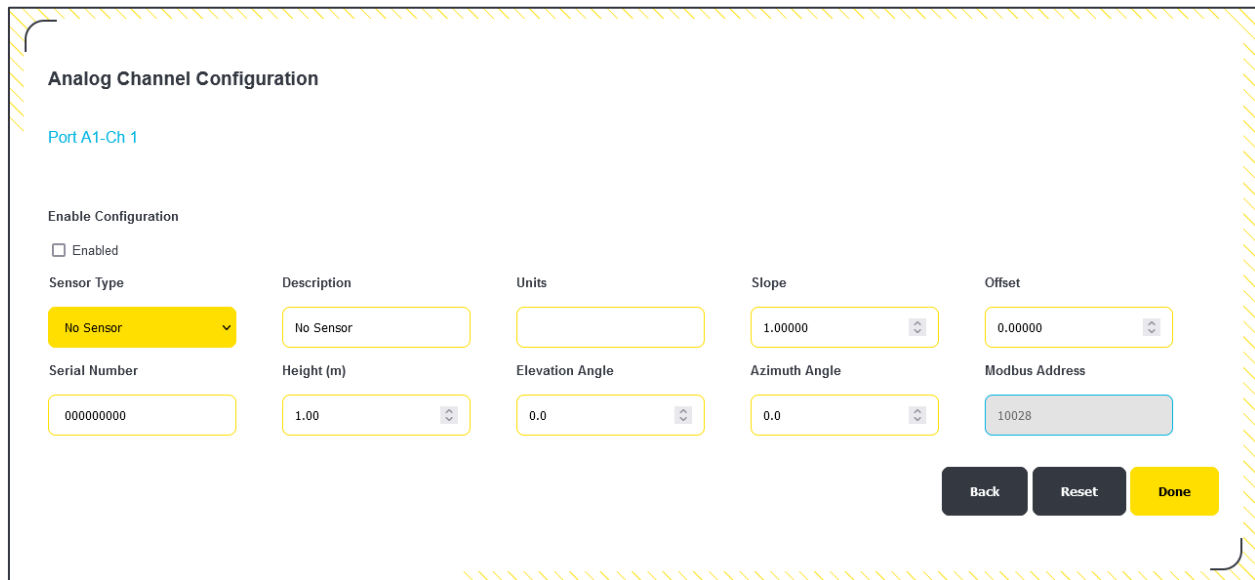



- Using the **Sensor Type** drop-down, select the correct sensor to be programmed onto this channel.
- Edit the “Description” as necessary.
- Edit the “Slope” and “Offset” fields if the sensor values differ from the default values. This is often only changed with calibrated sensors.
- Enter the sensor serial number. The field can include numerical and alphabetical characters if necessary.
- Enter sensor height in meters.
- Enter the elevation angle, azimuth angle, and vane mounting angle if applicable.
- Channels configured with a wind direction sensor (wind vane) will enable a **Gust Source Channel** dropdown menu. Select the configured Counter Channel of a wind speed sensor (anemometer) to pair the data.

Note: Wind gust is the highest 3-sec average wind run per averaging interval and is used for structural loading calculations. Pairing a direction channel to a wind speed channel allows the user to determine the direction from which a gust originates.

- Select **Done** when all relevant values have been entered to return to the **Analog Channels** page.
- Repeat with the remaining occupied analog sensor channels.

The newly configured channels are displayed as “**UNSAVED CHANGES.**”

Port	Channel	Description	Serial Number	
UNSAVED CHANGES				
A1	1	NRG BP20	180535758	<button>Configure</button>
	2	No Sensor	000000000	<button>Configure</button>
A2	3	No Sensor	000000000	<button>Configure</button>
	4	No Sensor	000000000	<button>Configure</button>
A3	5	No Sensor	000000000	<button>Configure</button>
	6	No Sensor	000000000	<button>Configure</button>
A4	7	No Sensor	000000000	<button>Configure</button>
	8	No Sensor	000000000	<button>Configure</button>



11. To confirm the newly configured channels, scroll to the bottom of the page and click the yellow **Save** button in the bottom right corner.

The screenshot shows a configuration interface with a table of channels. The table has four columns: Channel ID, Channel Number, Sensor Type, and Value. There are two rows of data. Below the table is an orange bar with the text 'UNSAVED CHANGES'. In the bottom right corner, there is a yellow 'Save' button.

A7	13	No Sensor	00000000
	14	No Sensor	00000000

UNSAVED CHANGES

Save



Modbus RTU Serial Sensors

LOGR supports up to 12 Modbus RTU sensors (6 on COM-A and 6 on COM-B) and 24 measurands in total. *Do not connect more than 6 RTU sensors and/or gather more than 12 measurands per COM port.* Both one-second and statistical (average, max, min, and standard deviation) are available via Modbus registers. The home page of the webserver provides a quick view of live data to ensure sensors are performing and are connected properly at set up time.

Serial Port Configuration

Navigate to the **Sensor** menu at the top of the page and select **Serial Ports Setup** from the drop-down options. This page allows for COM ports A and B to be set for differing Baud Rates, Stop Bits, Data Bits, and Parity, allowing for greater Modbus serial sensor accommodation. Click the yellow **Save** button on the bottom right of the page when configuration is complete.

The LOGR will reboot to reload the new settings.

Serial Port Setup

COM-A

Baud Rate

2400 9600 19200 38400 57600 115200 230400 460800 921600

Stop Bits

0 1 2

Data Bits

8 9

Parity

None Even Odd

COM-B

Baud Rate

2400 9600 19200 38400 57600 115200 230400 460800 921600

Stop Bits

0 1 2

Data Bits

8 9

Parity

None Even Odd

Cancel **Save**



Serial Channel Configuration

To configure serial sensors:

1. Navigate to the **Sensor** menu at the top of the page and select **Serial Sensor Setup** from the drop-down options.
2. Check the **Configured** checkbox.
3. Using the drop-down menus, select the **Port** (COM-A or COM-B), then the **Sensor Type** from the list of supported serial sensors.
4. Edit the **Sensor Description** as necessary. The field auto-populates with the Sensor Type chosen.
5. Edit the **Client Address** to match that of the programmed sensor ID.
6. Enter the sensor serial number provided by the manufacturer.
7. If utilizing the **Control Scheme** function to keep Hukseflux SR30 pyranometers within system temperature and timing limitations, select the pre-configured scheme from the dropdown menu. For further information, see the [Control Scheme Configuration](#) section below.
8. Scroll down and click the yellow **Save** button.

Configured	Port	Sensor Type	Sensor Description	Client Address	Serial Number	Control Scheme
<input type="checkbox"/>	COM-A	No Sensor	No Sensor	1	000001	No Control
<input type="checkbox"/>	COM-A	No Sensor	No Sensor	2	000001	No Control
<input type="checkbox"/>	COM-A	No Sensor	No Sensor	3	000001	No Control
<input type="checkbox"/>	COM-A	No Sensor	No Sensor	4	000001	No Control
<input type="checkbox"/>	COM-A	No Sensor	No Sensor	5	000001	No Control
<input type="checkbox"/>	COM-A	No Sensor	No Sensor	6	000001	No Control

Saving the Serial Sensor Setup page will automatically redirect to the **Serial Channels** page to specify the desired Measurands for the sensor.



To configure serial channels:

1. Select the desired previously configured sensor from the *Sensor* drop-down menu. This will automatically check the *Enabled* checkbox in the first column for the channel.
2. Select the desired Measurand from the drop-down menu.
3. Edit the *Slope*, *Offset* and *Units* fields if the default values need to be changed.
4. Channels configured with a wind direction sensor will enable a **Gust Source Ch** dropdown menu. Select the configured channel of a wind speed sensor to pair the data.

Note: Wind gust is the highest 3-sec average wind run per averaging interval and is used for structural loading calculations. Pairing a direction channel to a wind speed channel allows the user to determine the direction from which a gust originates.

Serial Channels

Enabled	Channel	Sensor	Measurand	Slope	Offset	Units	Gust Source Ch
<input checked="" type="checkbox"/>	101	Lufft WS600	Air Temperature (Act.)	0.10000	0.00000	deg_C	
<input checked="" type="checkbox"/>	102	Lufft WS600	Relative Humidity (Act.)	0.10000	0.00000	%	
<input checked="" type="checkbox"/>	103	Lufft WS600	Relative Air Pressure (Act.)	0.10000	0.00000	hPa	
<input checked="" type="checkbox"/>	104	Lufft WS600	Wind Speed Fast	0.10000	0.00000	m/s	
<input checked="" type="checkbox"/>	105	Lufft WS600	Wind Direction Fast	0.10000	0.00000	deg	104



- Repeat for as many channels as necessary and click the yellow **Save** button at the bottom of the screen to complete the channel configurations.

Serial Channels

Enabled	Channel	Sensor	Measurand	Slope	Offset
<input checked="" type="checkbox"/>	101	Hukseflux SR30	Irradiance	0.01000	0.00000
<input checked="" type="checkbox"/>	102	Hukseflux SR30	Irradiance (UC)	0.01000	0.00000
<input checked="" type="checkbox"/>	103	Hukseflux SR30	Body Temp	0.01000	0.00000
<input checked="" type="checkbox"/>	104	Hukseflux SR30	Humidity	0.01000	0.00000
<input checked="" type="checkbox"/>	105	Hukseflux SR30	Tilt	0.01000	0.00000
<input checked="" type="checkbox"/>	106	Hukseflux SR30	Heater Current	1.00000	0.00000
<input checked="" type="checkbox"/>	107	Hukseflux SR30	Fan Speed	1.00000	0.00000
<input type="checkbox"/>	108	No Sensor	No Measurand	1.00000	0.00000
<input type="checkbox"/>	109	No Sensor	No Measurand	1.00000	0.00000

After saving the channel configurations, the Web Interface will automatically route to the **Sensor Outputs** home page where Active channels report live data. The drop-down menu at the top right corner of the table allows alternative views of All, Active, Inactive, and Unconfigured channels.

Sensor Outputs

Active

Channel Number	Type	Description	Data
1	Analog	NRG BP20	0.00 hPa
101	Serial	Hukseflux SR30-Irradiance	0.97 W/m ²
102	Serial	Hukseflux SR30-Irradiance (UC)	0.96 W/m ²
103	Serial	Hukseflux SR30-Body Temp	34.25 deg_C
104	Serial	Hukseflux SR30-Humidity	11.04 %
105	Serial	Hukseflux SR30-Tilt	0.17 deg
106	Serial	Hukseflux SR30-Heater Current	335.00 mA
107	Serial	Hukseflux SR30-Fan Speed	9077.00 rpm



Control Scheme Configuration

Control Schemes can be configured to create pre-set actions for the Hukseflux SR30 pyranometer. Five different schemes for five different SR30 sensors can be configured and enabled for specific situations, such as turning on the heater for cold temperatures.

1. Navigate to the **Sensor** menu at the top of the page and select **Serial Sensor Control Setup** from the drop-down options.
2. Click the grey **Configure** button to edit and enable a control scheme.

Enabled	Control Scheme	Configure
<input checked="" type="checkbox"/>	Default Control Sch	Configure
<input type="checkbox"/>	Default Control Sch	Configure
<input type="checkbox"/>	Default Control Sch	Configure
<input type="checkbox"/>	Default Control Sch	Configure
<input type="checkbox"/>	Default Control Sch	Configure

Force Control Refresh Done

3. The page will redirect to allow configuration of the scheme where it can be renamed, and the sensor input channel selected.
 - Set the Heater ON threshold (in degrees Celsius), and/or the start and end time for the action.
 - The checkbox next to the timeframe can be unchecked for the action to be enabled anytime the temperature threshold is met during that timeframe or unchecked for the only controlling factor to be the temperature threshold.
 - Note that the SR30 fan will always run if/when the heater is enabled. The fan can only be disabled if the heater is not in use and the **Fan Always On** checkbox is unchecked.



- Click the yellow **Save** button to complete the set-up.

Serial Sensor Control

Control Scheme 3

Enabled

Scheme Name
Default Control Sch

SR30 Heater
The heater will remain on when any of the following conditions are enabled and met:

	Input Channel	Operator	Threshold
<input checked="" type="checkbox"/>	[Dropdown]	<	5.0

Start Time: 12:00 AM End Time: 12:00 AM

SR30 Fan
Fan Always On

Back Cancel Save

Force Control Refresh

Clicking the orange **Force Control Refresh** button on the bottom left corner of the Serial Sensor Control Schemes page allows a user to manually sync the state of the programmed Hukseflux SR30 pyranometers to the system configuration. This button should be clicked if the internal pyranometer heaters or fan are not behaving according to the programmed control scheme when conditions are met.



Counter Channel Configuration

LOGR supports up to 5 counter channels for anemometers and tipping bucket rain gauges. Both one-second and statistical (average, max, min, and standard deviation) are available via Modbus registers. The home page of the webserver provides a quick view of live data to ensure sensors are performing and connected properly after set-up.

1. Navigate to the **Sensor** menu at the top of the page and select **Counter Channel Setup** from the drop-down options. Select **Configure** next to the desired channel.

Port	Channel	Description	Serial Number	
C8	401	No Sensor	00000000	<button>Configure</button>
C9	402	No Sensor	00000000	<button>Configure</button>
C10	403	No Sensor	00000000	<button>Configure</button>

Selecting **Configure** for a specific channel will redirect to the **Analog Channel Configuration** page for the specified channel.

Counter Sensor Setup

Port C401-Ch 1

Enable Configuration
 Enabled

Sensor Type: No Sensor (dropdown)
Description: No Sensor (text field)
Units: (text field)
Slope: 1.00000 (spin box)
Offset: 0.00000 (spin box)

Serial Number: 00000000 (text field)
Height (m): 0.00 (spin box)
Elevation Angle: 0.0 (spin box)
Azimuth Angle: 0.0 (spin box)
Modbus Address: 10372 (text field)

Pull-Up: Enabled
Signal Type: Pulsed (dropdown)
Slow Filter Status: Disabled (text field)
Statistical Mathtype: Linear (text field)

Back Reset Done

2. Using the **Sensor Type** drop-down, select the correct sensor to be programmed onto this channel.
3. Edit the “Description” as necessary.
4. Edit the “Slope” and “Offset” fields if the included default values should be changed.



LOGR | Solar Data Logger

5. Enter the sensor serial number. The field can include numerical and alphabetical characters if necessary.
6. Enter sensor height in meters.
7. Enter the elevation angle, and azimuth angle, if necessary.
8. Enable pull-up, and change the signal type, if necessary.
9. Select **Done** when all relevant values have been entered to return to the **Counter Channels** page.
10. Repeat with any remaining counter sensor channels as needed.

The newly configured channels are displayed as “**UNSAVED CHANGES.**”

To confirm the newly configured channels, scroll to the bottom of the page and click the yellow **Save** button in the bottom right corner.

Counter Channels

Port	Channel	Description	Serial Number	
UNSAVED CHANGES				
C8	401	NRG S1 Anemometer	9405000072	Configure
C9	402	No Sensor	00000000	Configure
C10	403	No Sensor	00000000	Configure
C11	404	No Sensor	00000000	Configure
C12	405	No Sensor	00000000	Configure
UNSAVED CHANGES				

[Save](#)



Calculated Channels

Calculated channels are available to produce statistical values using data from sensor channels. They can be used for irradiance comparisons and solar angles to verify and troubleshoot data. There are a total of ten calculated channels available for configuration (301-310).

Direct Normal Irradiance (DNI)	Represents the amount of light arriving perpendicular, in a straight line, towards a surface such as the ground or a sensor. This value is derived based on time of day, latitude, longitude, global horizontal irradiance (GHI), and diffuse horizontal irradiance (DHI). This calculated channel requires a channel input source of GHI, and a channel input source of DIF (diffuse irradiance).
Solar Zenith Angle (SZA)	The angle between the zenith (an imaginary point directly above a location), and the center of the sun. This value is commonly used for solar data quality control and as input to additional calculations like DNI. The SZA is derived based on the time of day, time zone, latitude, and longitude. No sensor inputs are required for SAA; the logger clock, time zone, latitude, and longitude settings are used.
Solar Azimuth Angle (SAA)	The horizontal angle of the sun along the local horizon, measured clockwise from true north. For example, due east has an SAA value of 90 degrees, and due west has a value of 270 degrees. This value is commonly used for solar data quality control such as to troubleshoot unexpected shading or reflection issues. The SAA is derived based on the time of day, time zone, latitude, and longitude. No sensor inputs are required for SAA; the logger clock, time zone, latitude, and longitude settings are used.
Albedo	The ratio between reflected horizontal irradiance (RHI) and global horizontal irradiance (GHI). This ratio value is a measure of the reflectivity of a surface due to incoming solar radiation. To accurately calculate this value, two channels of the same type (i.e., analog or RS485) must be selected as the RHI (downward facing pyranometer) and the GHI (upward facing pyranometer) inputs. This ratio can be calculated for a tower albedometer or array albedometer. A high value (maximum of one, or 100%) indicates greater reflection by a surface back to the source. Complete absorption carries a value of zero.
Ratio	Enabled to derive a ratio between any two channels of the same type (i.e., analog or RS485). One channel is used for the numerator and one for the denominator. The description of this channel can be edited to reflect the relevant ratio title.
Hourly Sum	Totalizes the amount of precipitation for one hour. This value resets to zero at the beginning of each hour. Note that for Lufft sensors, the <i>Precipitation Diff</i> measurand channel should be enabled and then selected from the dropdown options for use with this calculated channel.



Daily Sum	Totalizes the amount of precipitation for one day. This value resets to zero at midnight local logger time. Note that for Lufft sensors, the <i>Precipitation Diff</i> measurand channel should be enabled and then selected from the dropdown options for use with this calculated channel.
Rainfall Intensity	Recalculates every minute based on the rate of rainfall in the past minute. The data is expressed as mm/hr. For example, if 2 mm of rain has fallen in the last minute, rainfall intensity equals 120 mm per hour. Note that for Lufft sensors the <i>Precipitation Diff</i> measurand channel should be enabled and then selected from the dropdown options for use with this calculated channel.
Daily Insolation	Totalizes the solar radiation energy for the day. It is updated each minute and resets to zero at midnight logger local time. This can be calculated with any irradiance channel and the value is expressed in kW/m ² /hour.
Elevation Angle	Uses the coordinates of the LOGR to determine the altitude angle between the horizontal plane and the sun in the sky.

Calculated Channel Configuration

To configure LOGR with calculated channels:

1. Navigate to the **Sensor** menu at the top of the page and select **Calculated Channels** from the drop-down options.
2. Click the grey *Configure* button on the right side of the desired channel.

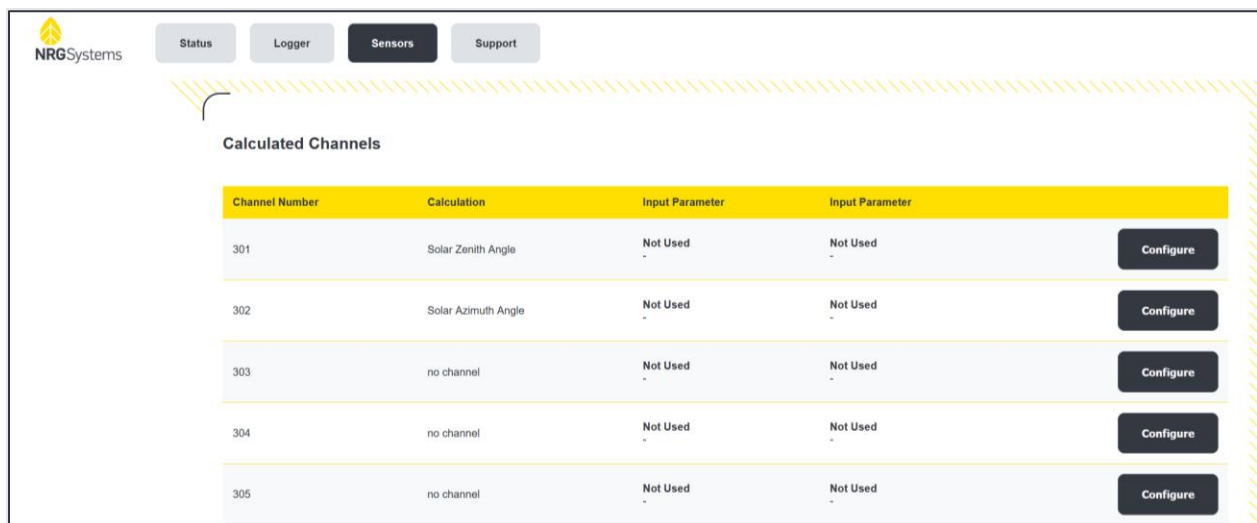



- Use the dropdown menu to select the *Calculation Type* then edit the *Calculation Description* as needed. Some channels such as Albedo or DNI require input from sensors to complete the requested calculation. The correct sensor channels need to be selected in the areas prompted (see the above channel descriptions for more information). Click the yellow **Save** button to confirm the channel edits.

Calculated Channel Configuration

Calculated Channel: 301

Calculation Type: No Calculation

Calculation Description: No Calculation

Save

- All ten calculated channels, configured or unconfigured, are visible on the Calculated Channels page. All active Calculated Channels will be visible on the **Sensor Outputs** home page.



PV Soiling Configuration

LOGR uses the NREL Soiling Method to measure and provide a Daily Soiling Ratio, which requires a **plane-of-array (POA) irradiance sensor** in addition to the **two PV panels**. Terminal ports on the front panel of LOGR are provided for landing wires from “PV Soil” and “PV Clean” panels.

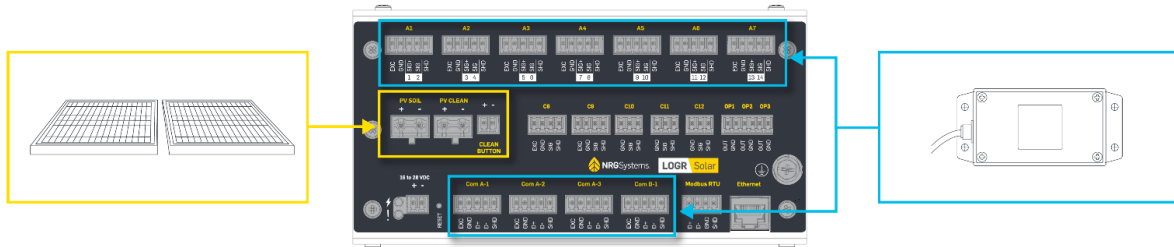

To configure PV soiling measurements:

1. Navigate to the **Sensor** menu at the top of the page and select **Soiling Ratio Setup** from the drop-down options.
2. Check the **Compute** box.
3. Select which calculation type is required under **Soiling Method**. The IEC method is exclusively used with polycrystalline panels and is the recommended method when using a [Pulsed Soiling Module](#), however it may also be used with 15A max/35 W soiling kits.

IEC Method:

1. Under *Clean PV Module* and *Soil PV Module* sections, input the information dictated by the PV panel specifications (sometimes found on a label directly on the panels). Default values will likely need to be changed.
2. Use the dropdown menus to select the correct sensor channels configured for PSM inputs and back of module temperature sensors for clean and soiled panels respectively.
3. To maintain IEC calculation compliance, maintain the default values for the *Soiling Calculation Filter*.
4. Click the yellow **Save** button.



Soiling Ratio Setup

Compute Soiling Ratio

Compute

Soiling Calculation Method

IEC 61724 Annex C (Recommended) Irradiance Corrected

Standard Test Conditions STC for PV Modules

Temperature (deg_C)
25.000000

Irradiance (W/m²)
1000.000000

Clean PV Module	Soil PV Module
Isc at 1000 W/m ² (A) 9.570000	Isc at 1000 W/m ² (A) 9.570000
Voc at 1000 W/m ² (V) 10.000000	Voc at 1000 W/m ² (V) 12.000000
Temperature Coefficient for Isc alpha (%/deg_C) 0.000500	Temperature Coefficient for Isc alpha (%/deg_C) 0.000500
Temperature Coefficient for Voc (%/deg_C) -0.002800	Temperature Coefficient for Voc (%/deg_C) -0.002800
Description Clean PV	Description Soiled PV
PSM Isc Input Channel 202-I Short Circuit Clean	PSM Isc Input Channel 204-I Short Circuit Dirty
PSM Voc Input Channel 203-V Open Circuit Clean	PSM Voc Input Channel 205-V Open Circuit Dirty
PV Temperature Input Channel 1-NRG PVT1 - clean	PV Temperature Input Channel 9-NRG PVT1 - soiled

IEC 61724 Soiling Calculation Filter

Include data where irradiance G is greater than (W/m²)
500.000000

Include data within this many hours of solar noon (Hours)
2.000000



IEC Method Channel Reporting:

Channels 202-203, viewable on the **Sensor Outputs** home page, report raw amperage and voltage values of the Clean panel.

202	PV	I Short Circuit Clean	-0.001 A
203	PV	V Open Circuit Clean	0.015 V

Channels 209-212, viewable on the **Sensor Outputs** home page, report automatically calculated data values when computing irradiance with IEC Annex C.

209	PV_IEC	Effective Irradiance Clean (G)	0.000 W/Sqm
210	PV_IEC	Soiling Ratio Isc Index (SRIsC)	0.000
211	PV_IEC	Daily Soiling Ratio	0.000
212	PV_IEC	Effective Irradiance Soil (G_Soil)	0.000 W/Sqm



Irradiance Corrected Method:

1. Select the configured **POA Irradiance Channel** from the drop-down menu options.
2. Click the yellow **Save** button.

Soiling Ratio Setup

Compute Soiling Ratio

Compute

Soiling Calculation Method

IEC 61724 Annex C (Recommended) Irradiance Corrected

Irradiance Corrected Settings

POA Irradiance Channel: 106-Hukseflux SR30-Irradiance

POA Irradiance: 443.2 W/m²

Soiling Ratio: 1.000

Back Cancel Save

Irradiance Corrected Method Channel Reporting:

This saved PV Soiling Ratio channel (201) can be viewed with the other Active channels on the **Sensor Outputs** home page, along with the raw soiling measurement channels (202-205).

201	PV	Soiling Ratio	1.000
202	PV	I Short Circuit Clean	0.000 A
203	PV	V Open Circuit Clean	0.015 V
204	PV	I Short Circuit Dirty	0.000 A
205	PV	V Open Circuit Dirty	0.000 V



Panel Cleaning:

Navigating to the **Sensor** menu at the top of the page and selecting **Soiling Ratio Setup** from the drop-down options also displays the date and time of the last panel cleaning.

The displayed “Last Cleaning Time” is collected on this page and in the corresponding Modbus Register either when the yellow **Clean Panel** (virtual) button is clicked on the page, or when a physical Solar Maintenance Button is pressed for two seconds.

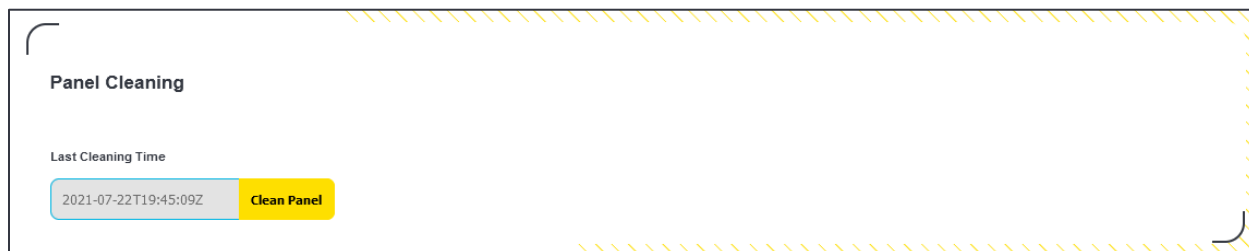

Note that clicking the virtual button will not actually physically clean the panel on site. For an easy way to record a cleaning or maintenance event, the [Solar Maintenance Button](#) can be added as an accessory to LOGR.

Pulsed Soiling Module Configuration

Another option which allows for PV soiling calculation is the NRG Soiling Measurement Kit. This includes a Pulsed Soiling Module (PMS1) that measures the Open Circuit Voltage and Short Circuit Current of a clean and soiled solar panel in accordance with IEC 61724-1. [The instructions for connecting this kit can be found here.](#)



Sensor Configuration Reset

Clearing all sensor configurations is possible by navigating to the **Logger** menu at the top of the page and selecting **Reset Sensor Config** from the dropdown menu. Clicking the orange **Reset** button will remove all values from the Analog, Serial, Soiling Station, and Calculated channels. Note that this action cannot be rescinded and exporting a sensor configuration is recommended before proceeding. See FTP Command Files to complete a sensor configuration export.

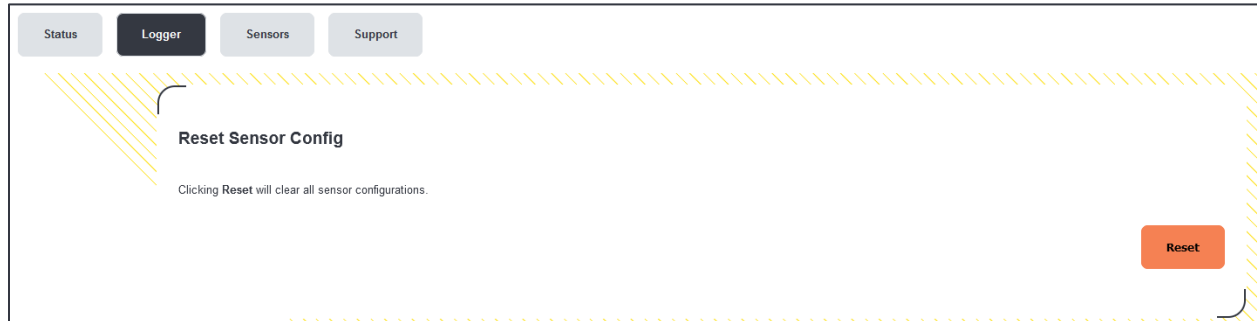



Changing LOGR Username and Password

For increased security, the logger username and password can be easily configured by navigating to the **Logger** menu on the top of the page and selecting the **Change Username or Password** option from the list.

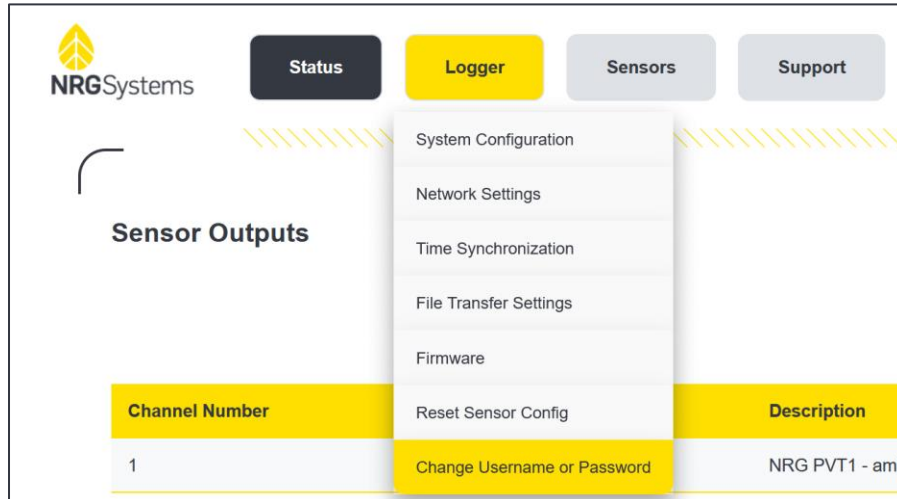

To change the logger Username, simply enter a new username in the box and click the yellow **Submit** button to save the changes. To change the logger password, enter the new password and confirm in the following box for double verification. Click the yellow **Submit** button to save the changes.

The screenshot shows two forms for configuration. The first form is titled 'Change Username' and has a 'New User Name' input field containing the text 'admin' and a yellow 'Submit' button. The second form is titled 'Change Password' and has two input fields: 'New Password' and 'Confirm New Password'. Each field has a 'Show Password' checkbox to its right. A yellow 'Submit' button is located at the bottom right of the form.

If username or password are lost, please contact NRG Systems Technical Services at support@nrgsystems.com for assistance.



Data Storage

To retrieve real-time data via Modbus TCP the logger should be connected to a SCADA network. The Modbus registers are pre-defined, allowing repeatable and streamlined data acquisition configuration. There is a backup of data contained on a non-removeable 8 GB internal microSD card embedded within the LOGR.

If a connection with the LOGR is lost, the internal micro-SD card will store files (data, diagnostics, and event logs) for up to 90 days of 1-second data collection. Disabling 1-second data recording reformats the internal micro-SD card to allow for 365 days of 1-minute averaged data. Note that all data should be retrieved and saved before reformatting the internal memory for a different file type, either 1-second or 1-minute averaged.

To change the data logging format, navigate to the **Logger** menu and select **System Configuration**. Scroll down to **Logging Options** to enable or disable 1-second data recording. Click the yellow **Save** button to continue with changes.

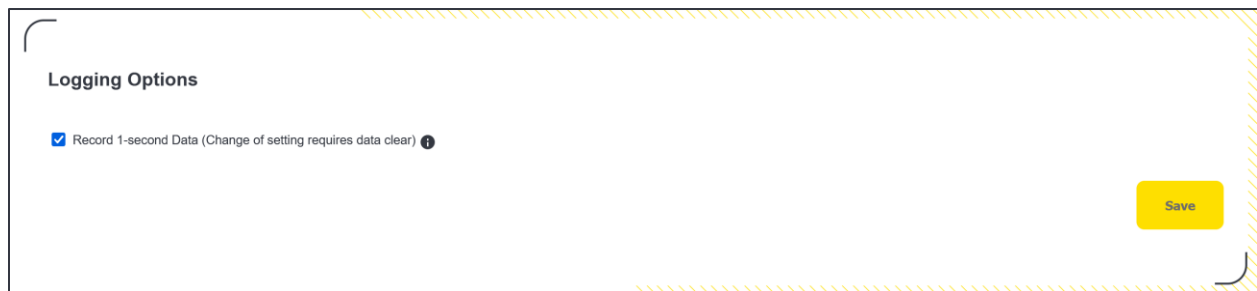

See [Data File Transfer](#) for further information.



Firmware Updates

The newest version of LOGR firmware is always available on the NRG Systems website at the following link: [NRG Systems LOGR | Solar Data Logger Firmware](#)

Note that LOGR-S and LOGR | Solar share backwards compatible firmware, starting with version 1.09.239.

To update firmware or view details of the firmware version, navigate to the **Logger** menu at the top of the page and select **Firmware** from the drop-down menu. This page details **Application Firmware Version**, **Bootloader Firmware Version**, and the firmware **Status**.

Note that if an [FTP](#) is being utilized, a copy of the current LOGR configuration is saved to the specified FTP when a firmware update is processed. Should all logger configurations be lost during a firmware update, it is recoverable via the saved information from FTP and can be imported via a [Command File](#).

Use of an FTP server for LOGR data backup is strongly recommended.



If an FTP is not utilized and all configurations are lost, there is no way to recover the information.

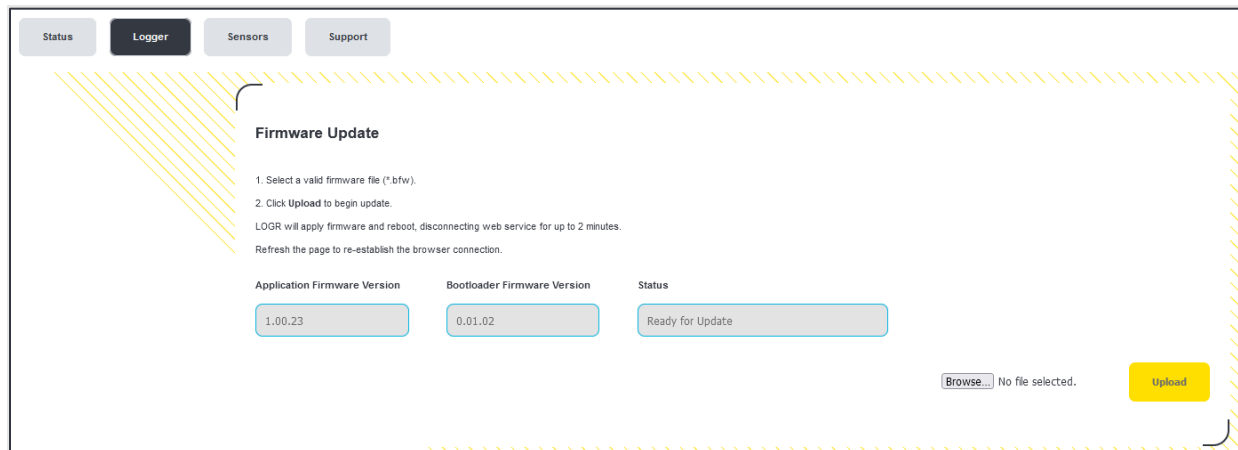

To update LOGR firmware using the web server, click the **Browse** button, navigate to, and open a valid .bfw firmware file. Click the yellow **Upload** button.

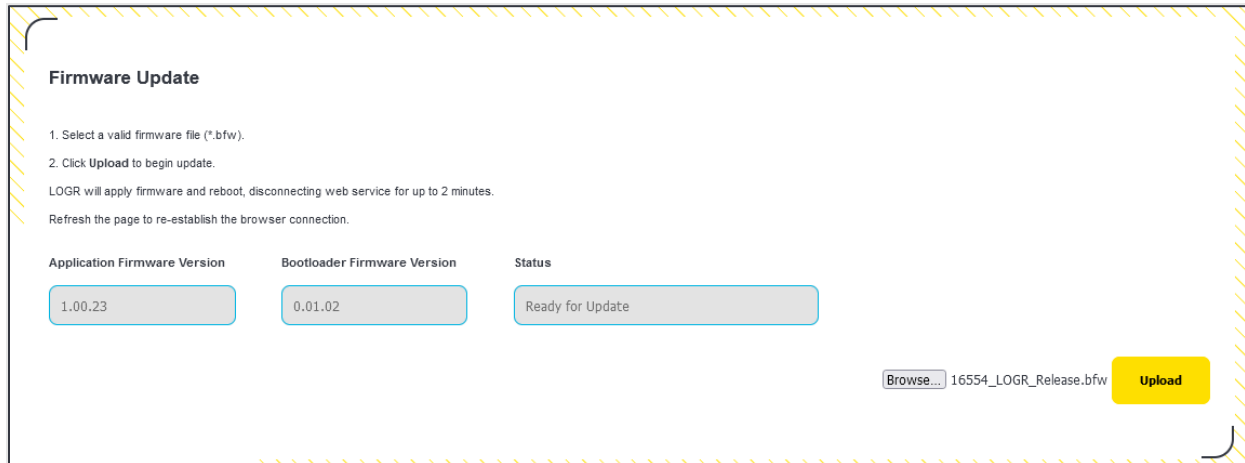

The LOGR will beep to confirm the action has been accepted by resetting and returning the web server to the **Sensor Outputs** home page. This process may take several minutes, during which the web server will be unresponsive. The LOGR will reboot when the action is completed, and the updated firmware can then be confirmed by navigating back to the **Firmware** page under the **Logger** menu.

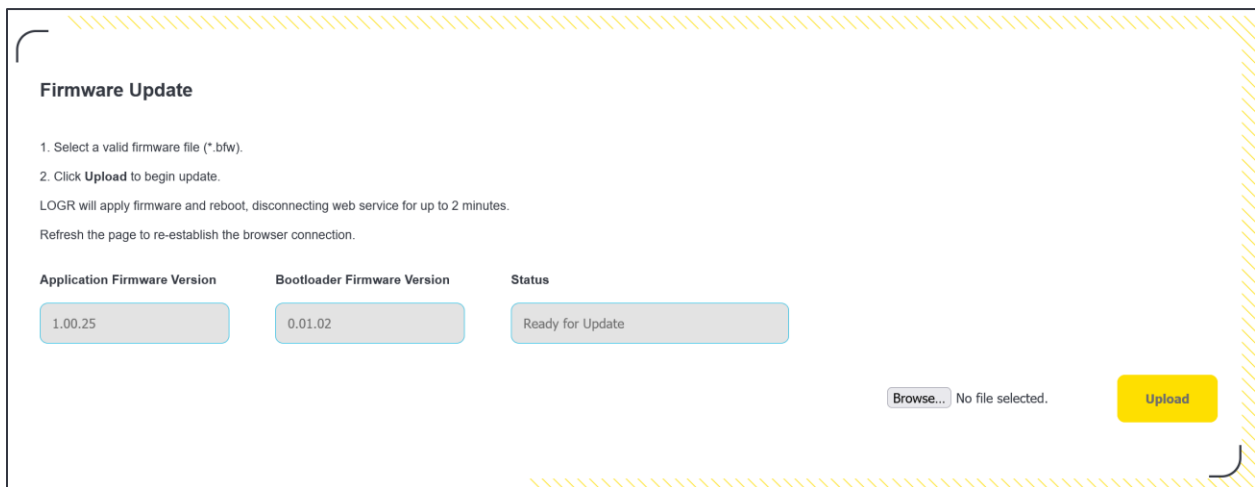



FTP

LOGR has a built-in FTP client capable of picking up a `command.ini` file from a local FTP server. Command files can be used to save sensor configurations, unit configurations, update the device firmware (which can also be completed using the web server), and reboot the logger. Note that much of the functionality of the FTP client and server can be more easily completed via the webserver.

Command Files

Command files are used to communicate between LOGR and the configured FTP server in both directions. Many of the actions completed with command files can also be completed with the web server. Command files will only be picked up by LOGR if the file name is `command.ini` and will only be processed if the file content is formatted correctly.

To enact a command file:

1. Navigate to the FTP server and find the command directory specified by the LOGR's File Transfer Settings.
2. Navigate to the folder for the LOGR in question (folder name is the serial number of the LOGR e.g., 000300). If the folder does not exist for the specified logger, create it.
3. Place the desired `command.ini` file and any necessary associated files onto the FTP server. Note that only ONE `command.ini` file can be placed in the folder at a given time.
4. Ensure the LOGR is configured to regularly check the FTP server for `command.ini` files (see File Transfer Settings)
5. Once the `command.ini` has been processed, the `command.ini` file and any associated files will have the unix timestamp appended to it, so that a user can identify that the file has been sent to the LOGR.



Command File Options

Command Type	Description	Contents
Reboot	This file commands the LOGR to reboot. Note that this command retains ethernet settings and does not return the unit to the default IP Address.	<code>[command] instruction = reboot</code>
Firmware Update*	This file commands an update to the LOGR firmware. Note that the updated firmware file (*.bfw) must also be placed on the FTP server and the name in the command.ini file must be the match the file on the server.	<code>[command] instruction = load fw file [file parameters] file name = 16554_LOGR_1_02_00.bfw [reboot parameters] reboot now = yes</code>
Export Sensor Configuration	To save the LOGR sensor configuration for transfer to another LOGR or to have as a backup, this command file can be placed on the FTP server. Once the export is complete, there will be a unit_config_XXXXX.bin file on the FTP server.	<code>[command] instruction = export sensor config</code>
Import Sensor Configuration	To import a formerly exported sensor configuration file to a LOGR, this command file can be placed on the FTP server. Ensure that the file to be imported has a name that matches the name in the command.ini file.	<code>[command] instruction = import sensor config [file parameters] file name = sensor_config_000300.bin</code>
Export Unit Configuration	To save LOGR unit configuration for transfer to another LOGR or to have as a backup, this command file can be placed on the FTP server. Once the export is complete, there will be a unit_config_XXXXX.bin file on the FTP server.	<code>[command] instruction = export unit config</code>



Import Unit Configuration	To import a formerly exported unit configuration file to a LOGR, this command file can be placed on the FTP server. Ensure that the file to be imported has a name that matches the name in the command.ini file.	<pre>[command] instruction = import unit config [file parameters] file name = unit_config_000300.bin</pre>
Export Files Configuration*	Data, Diagnostic, and Log files can be exported via a command.ini file. The data range and file type must be specified within the command file. Files will be exported to the “/data” folder in the subfolder of the same serial number as the LOGR they originated from.	<pre>[command] instruction = export data files [export dates] ; yyyy-mm- dd start date = 2021-09-01 end date = 2021-09-10 [file parameters] file type = samples only ; valid values are: stats only, samples only, stats and samples</pre>

**These command options are actionable via the webserver.*



Diagnostics

LOGR tracks all major voltages and currents in the system for diagnostic purposes and real time values can be viewed in the webserver. Navigate to the **Status** menu at the top of the page and select **Diagnostics** from the dropdown options. Diagnostic information is divided into three sections: Control, Analog, and Excitation Status.

Control Diagnostics

This section contains voltage and current information of the main (control) board of LOGR; these values are constantly monitored. Measurements within normal limits display a corresponding green status circle, while measurements not within tolerance show a red status circle to indicate an error condition.

Status	Register	Description	Data
●	10284	VIN Raw Power (V)	17.57
●	10286	VSENSE 12.4V (V)	12.43
●	10288	ISENSE 12.4V (mA)	1.61
●	10290	VSENSE 3.3V (V)	3.29
●	10292	ISENSE 3.3V (mA)	209.52
●	10294	VSENSE COM-A EXC (V)	12.39
●	10296	ISENSE COM-A EXC (mA)	0.81
●	10298	VSENSE COM-B EXC (V)	12.36
●	10300	ISENSE COM-B EXC (mA)	0.81



Analog Diagnostics

This section contains voltage and current information from the analog board of LOGR; these values are constantly monitored. Measurements within normal limits display a corresponding green status circle, while measurements not within tolerance show a red status circle to indicate an error condition.

Analog

● OK ✖ Error

Status	Register	Description	Data
●	10332	+VIN RAW POWER (V)	17.57
●	10334	VSENSE 13.3V (V)	13.42
●	10336	VSENSE 15V (V)	15.12
●	10338	VSENSE 12V (V)	12.08
●	10340	VSENSE 5V (V)	5.06
●	10342	-VIN RAW POWER (V)	-17.35
●	10344	VSENSE -15V (V)	-15.09
●	10346	ISENSE 12V (mA)	2.63

Excitation Status

This section displays the status of sensor excitations. In the event of a channel failure (for example, due to an electrical short or high current), the corresponding port (analog or serial) will display a red status circle to indicate an error condition.

Excitation Status

● OK ✖ Error

Status	Description
●	A1 EXCITATION
●	A2 EXCITATION
●	A3 EXCITATION
●	A4 EXCITATION
●	A5 EXCITATION
●	A6 EXCITATION
●	A7 EXCITATION
●	COM-A EXCITATION
●	COM-B EXCITATION



Counter Diagnostics

This section displays the status of Counter sensors faults. If an overcurrent condition were to occur, a red circle indicator would be present to signify an error.

Counter

● OK ✖ Error

Status	Register	Description
●	10428	Overcurrent Fault



Modbus Registers

This page displays a condensed Modbus map showing the boundaries of where different sections of the registers begin and their respective data types.

Navigate to the **Status** menu at the top of the page and select **Modbus Registers** from the dropdown menu.

[The full Modbus Map can be found here.](#)

Address	Description	Data Type
2	Format Float 12354678	float
4	Format 32Bit 123456789	uint32
6	Format 16Bit 12345	uint32
8	Posix Time	uint32
10	SD Free Space	uint32
12	Serial Number	uint32
14	Model Number	uint32
18	Firmware Version	uint32
26	System Status Registers	uint32
10000	One Second TimeStamp	uint32
10024	Soiling Ratio	float
10026	Clean Event Time (s)	uint32
10028	One Second Analog Channels	float
10140	One Second Serial Channels	float
10236	One Second Calculated Channels	float
15000	Statistical TimeStamp	uint32
15012	Statistical Analog Channels	float
15460	Statistical Serial Channels	float
15844	Statistical Calculated Channels	float
16020	Statistical Control Diagnostic Channels	float
16196	Statistical Analog Diagnostic Channels	float



Status Registers

LOGR constantly monitors various parameters and functions. Navigating to the **Status** menu at the top of the page and selecting **Status Registers** from the dropdown menu will display several status registers. All registers are available via SCADA; however, the critical parameters (Modbus Registers 32 and 34) are displayed on this page and can be reviewed for major function faults. Registers within normal limits display a corresponding green status circle, while registers not within tolerance show a red status circle to indicate an error condition.

Fault Registers

● OK
 ✖ Error

Description of Fault	Modbus Register (Bit)	Fault
COM A Error	Register 32 (Bit 0)	●
COM B Error	Register 32 (Bit 1)	●
Analog Board Timeout	Register 32 (Bit 2)	●
PV Board Timeout	Register 32 (Bit 3)	●
Unit Config CRC Fault	Register 32 (Bit 16)	●
Sensor Config CRC Fault	Register 32 (Bit 17)	●
No Analog Voltage Reference	Register 32 (Bit 18)	●
FTP Connection Fault	Register 34 (Bit 0)	●
FTP Transfer Fault	Register 34 (Bit 1)	●
FTP Directory Fault	Register 34 (Bit 2)	●
HTTP Fault	Register 34 (Bit 3)	●
SNTP Fault	Register 34 (Bit 4)	●
TCP Fault	Register 34 (Bit 5)	●
DNS Fault	Register 34 (Bit 6)	●
DHCP Fault	Register 34 (Bit 7)	●
Ethernet Overrun	Register 34 (Bit 8)	●
SD Card Fault	Register 34 (Bit 9)	●
Mains Power Fault	Register 34 (Bit 10)	●



SECTION 4 | FIELD INSTALLATION

Grounding & Lightning Considerations



A properly grounded system helps protect the logger, sensors, and data.

It is the responsibility of the installer to provide proper earth grounding for the tower, logger, and sensors. All warranty coverage for NRG Systems instruments and sensors is void if the system is improperly grounded.

Meteorological sensors, loggers, and towers accumulate static electrical charge unless they are properly grounded. High winds, low humidity, and the height of the tower above ground increase the rate of charge accumulation. Charge continues to accumulate until the developed voltage difference, sometimes thousands of volts relative to ground, causes dielectric breakdown and an electrostatic discharge (ESD). ESD can damage any scientific instrument or sensor, including NRG loggers, pyranometers, and other sensors. **Any structure that the logger is mounted to must be carefully grounded and protected against lightning.** The same careful grounding of the logger and sensors provides the best protection against lightning damage as well.



The LOGR grounding terminal, labelled with chassis ground symbol to the left must be connected to a suitable earth ground.

*The LOGR internal over-voltage and noise suppression systems use this chassis ground as the path to return ESD, overvoltage, or noise currents to ground. **The ground terminal should be properly connected before any other wiring is connected to the logger.***

Suitable grounding can include a local earth terminal (such as a driven ground rod) and its connected grounding conductor. In grid-connected applications, the electrical safety ground may be suitable. The NRG shelter box kit which includes the AC grid power supply provides a grounding connection to the electrical grid safety ground.

The logger provides internal connections at the “SHLD” terminal of each sensor terminal block to the LOGR chassis ground. These terminals make it easy to connect the cable shields for each sensor cable to ground.



Mounting

Within a shelter box, LOGR mounts onto a 35mm DIN Rail with a pair of removeable insulating clips (included).



To install LOGR onto 35 mm DIN Rail:

1. Anchor the bottom of the black attachment clips on the back of the LOGR onto the bottom edge of the DIN rail by angling the unit.
2. Push the unit upward to compress the clip attachment springs.
3. Push the top towards the rail.
4. Release the unit onto the rail and check the unit is secure.



LOGR was designed to be installed in an enclosure rated for environmental protection of IP66 or better.

Do not install LOGR in an unprotected location outdoors.



Required Tools

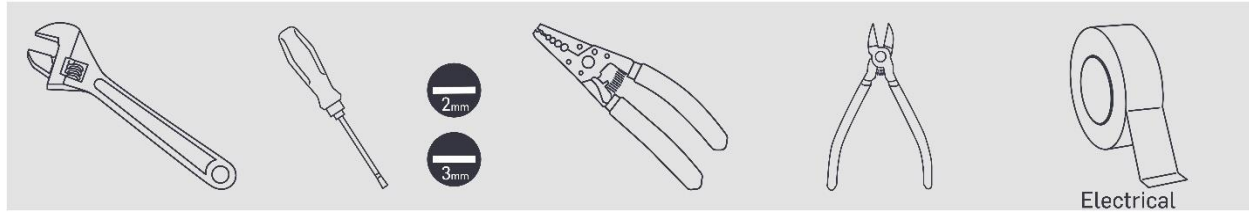

Sensor Connections

Routing Sensor Cables into the Shelter Box

To protect the contents of the shelter box from the outside environment, install strain reliefs (rubber sealing gaskets or grommets) into the holes in the bottom of the shelter box where wires will pass into the box. The table below contains types of strain reliefs offered by NRG Systems, although other types may be sourced elsewhere.

NRG Part Number	Part Description	Part Specification	Maximum Cables
12590	Strain Relief	Break-thru/Skinned-over .17"-.22" cable diameter 3/4" NPT threaded	5
16506	Strain Relief	Break-thru/Skinned-over .13"-.25" cable diameter M32-5 threaded	7
16545	Strain Relief	Break-thru/Skinned-over .24"-.30" cable diameter 1" NPT threaded	5

To pass a cable through a break-thru strain relief, carefully puncture the rubber grommet before passing sensor wires through the resulting hole. When using grommets or gaskets with a set number of pre-made holes, seal the unused holes with plumber's putty or short sections of scrap cable (1-2" long).

After all wires have been installed and extra holes have been plugged, seal the strain relief by tightening the outer shell around the gasket & cables.

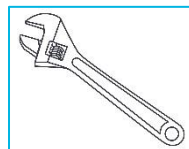

All wires coming down a tower and into the shelter box should be secured to the mast below the shelter box and then looped back up to form a drip-loop before entering the shelter box.

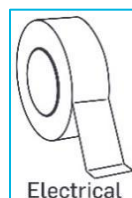



Connecting Sensor Wires to LOGR

Two single-ended sensors **or** one differential sensor can be connected to each analog port.

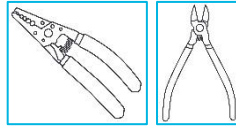

*Sensor wires should be stripped to expose only **6 to 7 mm (1/4 inch) of bare wire**. Stripping off additional insulation could allow bare wires to touch and cause an electrical short.*

If sensor wires come pre-stripped beyond 7 mm (1/4 inch), then trim the exposed ends to the correct length.

Connect the individual sensor wires to the supplied terminal plugs. Note that these terminal plugs are removeable and directional. They can only be inserted with the wire cages facing downwards. The wiring positions are indicated below each channel on the LOGR faceplate.

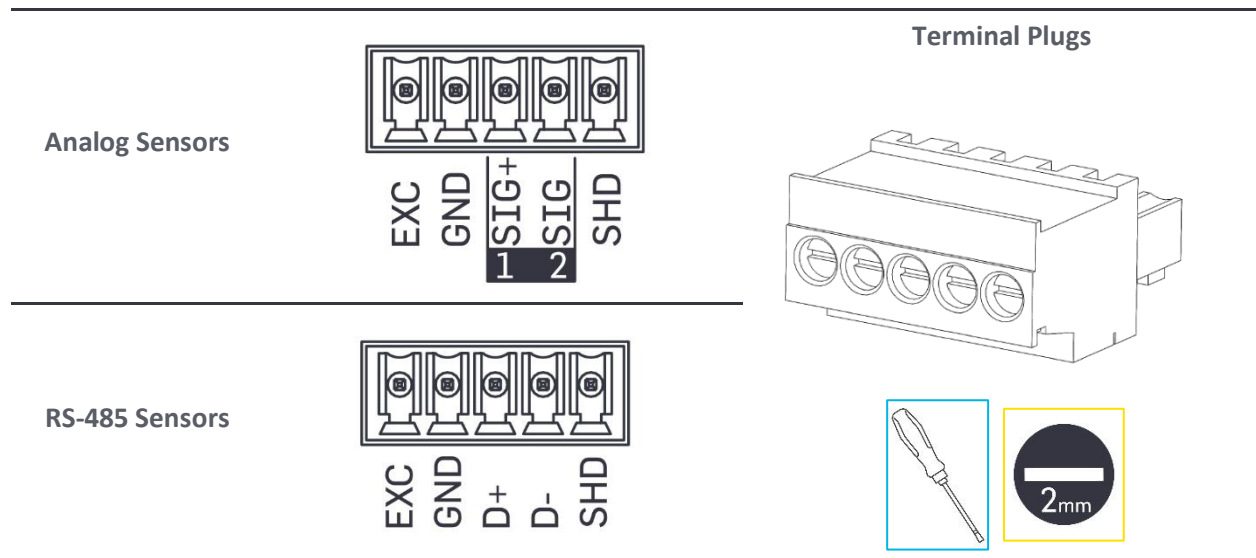

There are two signal terminals to each analog sensor port: **SIG+** and **SIG** with accompanying channel numbers below.

When connecting a single-ended analog sensor to a port, land the signal wire in the SIG+/SIG terminal that corresponds to the channel number configured for the sensor on the Web Interface. For example, if the (single-ended) NRG BP60 sensor is configured on channel 4, the signal wire must land in port A2, terminal SIG, channel 4.

When connecting a differential sensor, both SIG+/SIG terminals are used by the sensor so the even channel number of the pair cannot be configured. For example, if a pyranometer is connected to port A5, the signal wires land on both terminal SIG+ **and** SIG (channels 9 and 10). The data will be recorded to channel 9 and there will be no information for channel 10.



After all sensors have been connected to the wiring panel:

- Confirm correct wiring by reviewing each sensor channel on the Web Interface.
- Coat the stripped ends of the wires or the jaws of the plugs with an anti-corrosive product (such as PreservIT P100L from Caig Laboratories or Vaseline petroleum jelly).



Labeling the end of sensor wires during installation is recommended for future configuration and troubleshooting.

Connecting Soiling PV Panels to LOGR

Larger terminals are used for connecting PV panels to measure soiling ratio. They differ from the sensor terminals and are not cross-compatible.

Soiling PV Panels

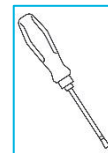
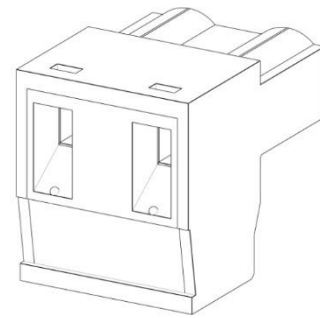
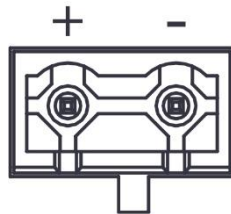

All cables between solar panels and LOGR must be rated for the open circuit voltage and short circuit current of the solar panel. Some compatible PV panels produce hazardous voltages. See the safety information section of this manual.

Strip wires from 7 to 8 mm (0.28 to 0.31 inch). See Wire Sizes, Strip Lengths, and Torques section of manual.



Solar Maintenance Button

The NRG Solar Maintenance Button is an optional accessory which pairs with and is mounted near a Soiling Station. Pushing this button after cleaning the “Clean” Soiling Station PV panel, or after other maintenance will create a data timestamp to note the event.



The timestamp is also visible on the LOGR web UI by navigating to the **Sensors** menu and selecting **Soiling Ratio Setup**. Alternatively, after cleaning or maintenance, the yellow “Clean Panel” button can be clicked to record the event.



Installation and Logger Configuration

The Solar Maintenance Button is designed with a simple mounting bracket which utilizes a hose clamp for installation onto a tower, boom, or torque tube. The kit is sold with either a 3m (kit 18904) or 20m cable length (kit 18905).

Simply feed the hose clamp through the bracket mounted to the back of the button housing. Locate the button at an easily accessible height within cable distance to the logger and tighten the hose clamp using a 5/16” hex driver, socket, or slotted screwdriver.

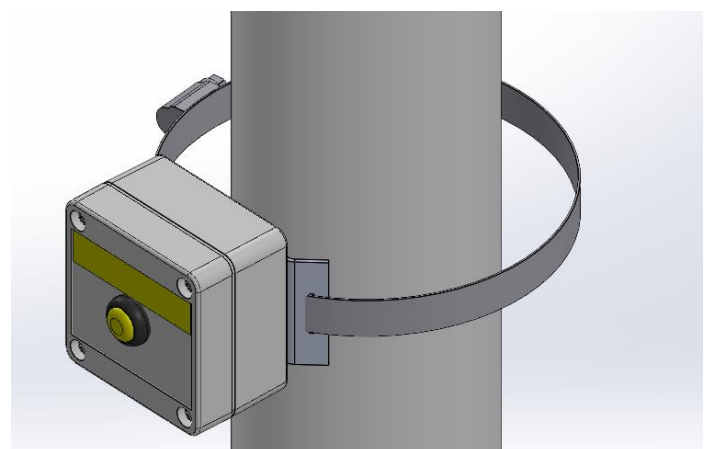



LOGR | Solar Data Logger

To connect the button to the logger, use a small flathead screwdriver to secure the 2-wire button cable into the dedicated “Clean Button” terminal block on the face of the LOGR, next to the Soiling Station terminals. Note that the button cabling is *not* polarity sensitive.

No additional programming is required to use the Solar Maintenance Button with LOGR. The button can be tested by pressing and checking the timestamp present on the LOGR web UI.

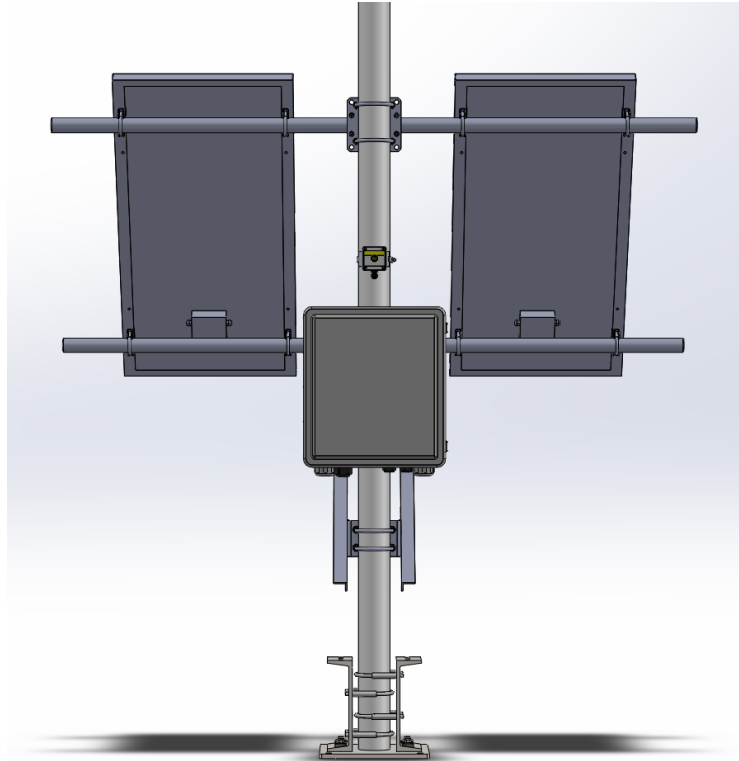



Connecting Relays to LOGR

Relays can be applied to LOGR | Solar to support a variety of functions such as turning an externally heated ventilator on and off. Output relays can be connected to the OP1-OP3 terminal blocks on the face of the logger for a total of three distinct output setups.

Common relay wiring:

Several output relay models have been evaluated and approved, such as the Murr Elektronik Miro 6.2, and the AutomationDirect 781-1C-SKT relay socket.

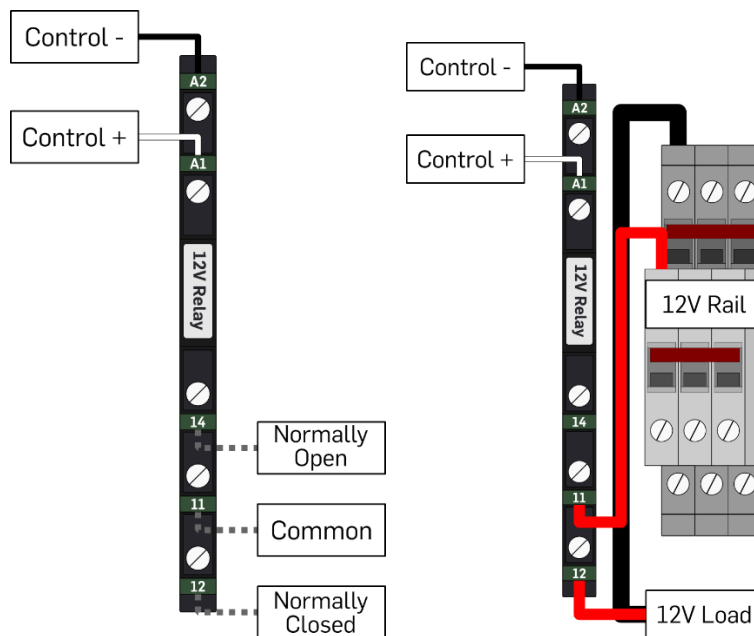

Terminal:	Call Out:	Connects to:	Use:
A1	Control +	OP Out	Relay Trigger
A2	Control -	OP GND	Relay Trigger Ground
11	Common	12V Rail (switched input)	Feeds 12 V+ power to the relay from the power supply
12	Normally Closed (NC)	From 12 V+ power supply OR not used	When relay is triggered, DC power is cut to this terminal
14	Normally Open (NO)	From 12 V+ power supply OR not used	When relay is triggered, DC power flows to this terminal

The Normally Closed (NC) terminal has a usual state of a completed circuit (power ON). This terminal should be used if the intent is to **open** the terminal should the logger power down, thus turning power OFF. The Normally Open (NO) terminal has a usual state of an incomplete circuit (power OFF). This terminal should be utilized if the intent is to **close** the terminal should the logger power down, thus turning power ON. The 12V Common terminal is always utilized and connects to the desired output terminal (NO or NC) to complete the trigger action.



Configuring Output Controls

1. Navigate to the **Sensor** menu at the top of the page and select **Output Control Setup** from the drop-down options.
2. Check the **Enabled** box next to the Output number to create an Output Control scheme.
3. Name the scheme as desired.
4. Check the box to **Enable an Input Channel** that will control the relay.
5. Select the **Input Channel** from the dropdown menu and set the threshold value.
6. If specific timing conditions are required for this Output Control, check the **Enabled Time Condition** box, and input a **Start** and **End Time**.

Output Control Setup

Output 1 Enabled

Input Channel Enabled

Input Channel 3-NRG PVT1 **Threshold** < 0.0

Enabled Time Condition

Start Time 12 : 00 AM **End Time** 12 : 00 AM



Sensor Wiring Map









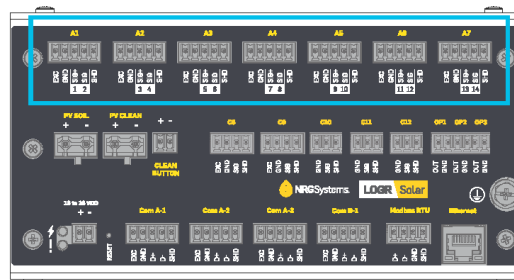

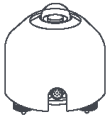

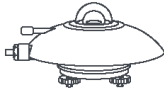







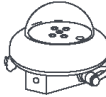



















Refer to this diagram to connect standard sensors to the LOGR or refer to the manufacturer's instructions for each sensor. This is not a complete list of sensors compatible with LOGR | Solar.

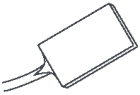

LOGR | Solar - WIRING MAP Analog Channels (A1-A7)

Page 1 of 5



<p>EKO MS-80</p>  <p>Sensor</p> <p>Logger</p> <p>Brn  ----- EXC Wht  ----- GND Bare ----- SIG+ ----- SIG ----- SHD</p>	<p>Hukseflux SR11, SR12, and SR20</p>  <p>Sensor</p> <p>Logger</p> <p>Wht  ----- EXC Grn  ----- GND Blk  ----- SIG+ ----- SIG ----- SHD</p>	<p>Kipp & Zonen CMP3, CMP10, CMP11</p>  <p>Sensor</p> <p>Logger</p> <p>Wht  ----- EXC Grn  ----- GND Blk  ----- SIG+ ----- SIG ----- SHD</p>	<p>Delta-T SPN1</p>  <p>Sensor</p> <p>Logger</p> <p>Pnk  ----- EXC Grn  ----- GND * Wht  ----- SIG+ GHI * Brn  ----- SIG DIF Braid ----- SHD Red  ----- Heater Power Supply Blu  ----- Heater Ground</p>
<p>NRG PVT1</p>  <p>Sensor</p> <p>Logger</p> <p>Red  ----- EXC Blk  ----- GND Grn  ----- SIG+ Wht  ----- SIG Shield ----- SHD</p>	<p>NRG T60 or 110S</p>  <p>Sensor</p> <p>Logger</p> <p>Red  ----- EXC Blk  ----- GND * Wht  ----- SIG+ ----- SIG Shield ----- SHD</p> <p><i>Note: Use on Ch. 14 for SR30 Control</i></p>	<p>NRG BP65, BP60, and BP20</p>  <p>Sensor</p> <p>Logger</p> <p>Red  ----- EXC Blk  ----- GND * Wht  ----- SIG+ ----- SIG Shield ----- SHD</p>	<p>NRG RH5X</p>  <p>Sensor</p> <p>Logger</p> <p>Red  ----- EXC Blk  ----- GND * Wht  ----- SIG+ ----- SIG Shield ----- SHD</p>
<p>PT100, PT1000 or Thermistor, 4-wire connection</p>  <p>Sensor</p> <p>Logger</p> <p>Current ----- EXC Common ----- GND Signal+ ----- SIG+ Signal ----- SIG ----- SHD</p>	<p>RM Young Vert Prop 27106</p>  <p>Sensor</p> <p>Logger</p> <p>Terminal A ----- GND * Terminal B ----- SIG+ ----- SIG ----- SHD</p>	<p>NRG 200M</p>  <p>Sensor</p> <p>Logger</p> <p>Red  ----- EXC Blk  ----- GND * Wht  ----- SIG+ ----- SIG Shield ----- SHD</p>	<p>*</p> <p>This is a single-ended sensor. Signal wire may be connected to either SIG+ or SIG, and may share EXC, GND, and SHD with another single-ended sensor.</p> <p>See user manual for more information.</p>







5-16-2024

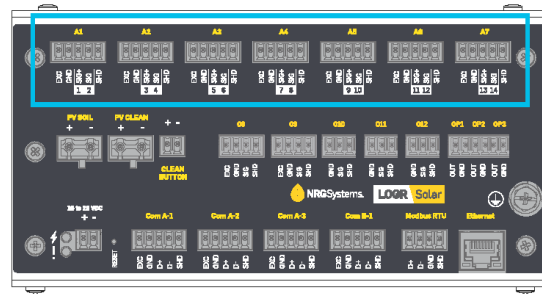

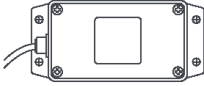
LOGR | Solar - WIRING MAP Analog Channels (A1-A7) Cont.

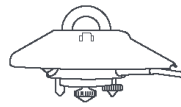
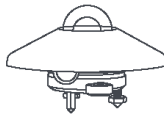
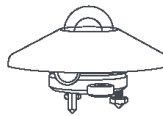
Page 2 of 5

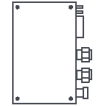

<p>Atonometrics RC18</p>  <p>Sensor Logger</p> <p>Pnk ■ ----- EXC Blk ■ ----- GND Grn ■ ----- SIG+ Brn ■ ----- SIG Bare ----- SHD</p>	<p>Hukseflux SR05</p>  <p>Sensor Logger</p> <p>Brn ■ ----- EXC Blk ■ ----- GND Blu ■ ----- SIG+ SIG Ylw ■ ----- SHD</p>	<p>Kipp & Zonen SUV5-V Radiometer</p>  <p>Sensor Logger</p> <p>Wht ■ ----- EXC Blk ■ ----- GND SIG+ Grn ■ ----- SIG Bare ----- SHD</p>	<p>NRG R1</p>  <p>Sensor Logger</p> <p>Brn ■ ----- EXC Wht ■ ----- GND Blu ■ ----- SIG+ SIG Ylw ■ ----- SHD</p>
<p>NRG R2 (Analog)</p>  <p>Sensor Logger</p> <p>Brn ■ ----- EXC Wht ■ ----- GND Blu ■ ----- SIG+ SIG Ylw/Grn ■ ■ ----- SHD</p>	<p>IMT Reference Cell</p>  <p>Sensor Ext Wire Logger</p> <p>Red ■ --- Brn ■ --- EXC Blk ■ --- Wht ■ --- GND Orng ■ --- Grn ■ --- SIG+ Brn ■ --- Ylw ■ --- SIG Thick Blk ■ --- SHD</p>	<p>NRG PSM1</p>  <p>Sensor Logger</p> <p>Red ■ ----- EXC Blk ■ ----- GND Blu ■ ----- SIG+ Grn ■ ----- SIG Shd ■ ----- SHD</p> <p>2nd Port</p> <p>Sensor Logger</p> <p>Ylw ■ ----- SIG+ Brn ■ ----- SIG</p>	
<p>NRG Grid Voltage Monitor</p>  <p>Logger</p> <p>Gry ■ ----- EXC Wht ■ ----- GND SIG+ SIG SHD</p>			









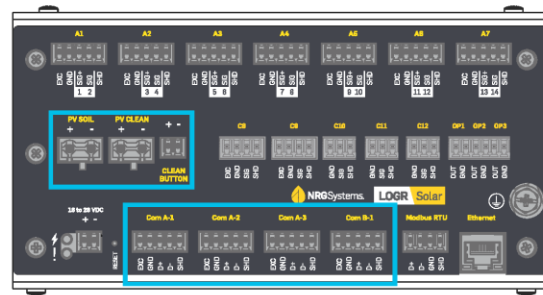

LOGR | Solar - WIRING MAP

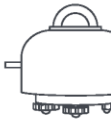
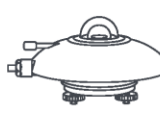
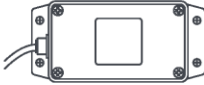
Serial Channels (COM-A1 to COM-B1) and PV Panels for Soiling

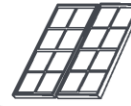
Page 3 of 5



<p>EKO MS-80S</p>  <p>Sensor Logger</p> <ul style="list-style-type: none"> Brn ■ EXC Wht □ GND Blu ■ D+ Blk ■ D- Ylw ■ SHD 	<p>EKO MS-40M</p>  <p>Sensor Logger</p> <ul style="list-style-type: none"> Brn ■ EXC Wht □ GND Blu ■ D+ Blk ■ D- Gry ■ & Shield SHD 	<p>Hukseflux SR30-D1</p>  <p>Sensor Logger</p> <ul style="list-style-type: none"> Brn ■ EXC Blk & Blu ■ GND Wht □ D+ Gry ■ D- Ylw ■ SHD 	<p>Hukseflux SR20-D2</p>  <p>Sensor Logger</p> <ul style="list-style-type: none"> Red ■ EXC Blu ■ GND Wht □ D+ Grn ■ D- Blk ■ SHD
<p>Atonometrics RC18</p>  <p>Sensor Logger</p> <ul style="list-style-type: none"> Pnk ■ EXC Blk ■ GND Wht □ D+ Pur ■ D- Shield SHD 	<p>Kipp & Zonen DustIQ</p>  <p>Sensor Logger</p> <ul style="list-style-type: none"> Wht □ EXC Blk ■ GND Ylw ■ D+ Gry ■ D- Blu ■ SHD 	<p>Lufft WS100, WS200, WS300, WS500, WS600</p>  <p>Sensor Logger</p> <ul style="list-style-type: none"> Brn ■ EXC Wht □ GND Grn ■ D+ Ylw ■ D- Braid SHD 	<p>PV Panels for Soiling</p>  <p>Panels Logger</p> <ul style="list-style-type: none"> Red ■ + Blk ■ - <p>or</p> <ul style="list-style-type: none"> Wht □ + Blu ■ - <p>or</p> <ul style="list-style-type: none"> Wht □ + Blk ■ -
<p>NRG R1-D</p>  <p>Sensor Logger</p> <ul style="list-style-type: none"> Brn ■ EXC Wht □ D+ Blu ■ GND Blk ■ GND Gry ■ D- Ylw ■ SHD 	<p>Kipp & Zonen SMP10</p>  <p>Sensor Logger</p> <ul style="list-style-type: none"> Wht □ EXC Blk & Blu ■ GND Ylw ■ D+ Gry ■ D- Shield SHD 	<p>Kipp & Zonen SUV-5-V</p>  <p>Sensor Logger</p> <ul style="list-style-type: none"> Wht □ EXC Blk ■ GND Ylw ■ D+ Gry ■ D- Thick Blk SHD 	<p>IMT Reference Cell</p>  <p>Sensor Ext Wire Logger</p> <ul style="list-style-type: none"> Red ■ Brn ■ EXC Blk ■ Wht □ GND Brn ■ Ylw ■ D+ Orng ■ Grn ■ D- Thick Blk SHD



LOGR | Solar - WIRING MAP

Serial Channels (COM-A1 to COM-B1) and PV Panels for Soiling Cont.

Page 4 of 5

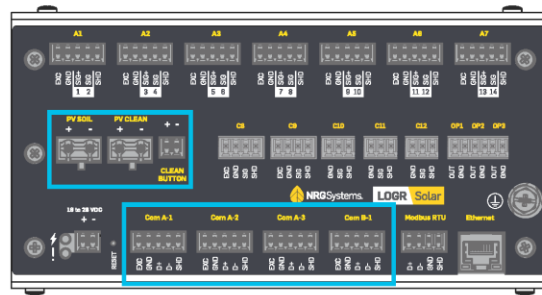

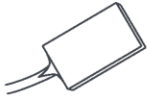
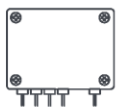
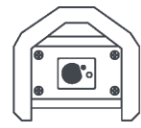
IMT BoM-T	RDE 300i	Lufft SHM31																																															
																																																	
<table border="0"> <tr> <td>Sensor</td> <td>Ext Wire</td> <td>Logger</td> </tr> <tr> <td>Red</td> <td>Brn</td> <td>EXC</td> </tr> <tr> <td>Blk</td> <td>Wht</td> <td>GND</td> </tr> <tr> <td>Brn</td> <td>Ylw</td> <td>D+</td> </tr> <tr> <td>Orng</td> <td>Grn</td> <td>D-</td> </tr> <tr> <td></td> <td>Thick Blk</td> <td>SHD</td> </tr> </table>	Sensor	Ext Wire	Logger	Red	Brn	EXC	Blk	Wht	GND	Brn	Ylw	D+	Orng	Grn	D-		Thick Blk	SHD	<table border="0"> <tr> <td>Sensor</td> <td>Logger</td> </tr> <tr> <td>Brn</td> <td>EXC</td> </tr> <tr> <td>Blk</td> <td>GND</td> </tr> <tr> <td>Gry</td> <td>D+</td> </tr> <tr> <td>Wht</td> <td>D-</td> </tr> <tr> <td>Blu</td> <td>None</td> </tr> <tr> <td>Shield</td> <td>SHD</td> </tr> </table>	Sensor	Logger	Brn	EXC	Blk	GND	Gry	D+	Wht	D-	Blu	None	Shield	SHD	<table border="0"> <tr> <td>Sensor</td> <td>Logger</td> </tr> <tr> <td>Brn</td> <td>EXC</td> </tr> <tr> <td>Wht</td> <td>GND</td> </tr> <tr> <td>Grn</td> <td>D+</td> </tr> <tr> <td>Ylw</td> <td>D-</td> </tr> <tr> <td>Gry</td> <td>GND</td> </tr> <tr> <td>Shield</td> <td>SHD</td> </tr> </table>	Sensor	Logger	Brn	EXC	Wht	GND	Grn	D+	Ylw	D-	Gry	GND	Shield	SHD	
Sensor	Ext Wire	Logger																																															
Red	Brn	EXC																																															
Blk	Wht	GND																																															
Brn	Ylw	D+																																															
Orng	Grn	D-																																															
	Thick Blk	SHD																																															
Sensor	Logger																																																
Brn	EXC																																																
Blk	GND																																																
Gry	D+																																																
Wht	D-																																																
Blu	None																																																
Shield	SHD																																																
Sensor	Logger																																																
Brn	EXC																																																
Wht	GND																																																
Grn	D+																																																
Ylw	D-																																																
Gry	GND																																																
Shield	SHD																																																





LOGR | Solar - WIRING MAP

Counter Channels (C8-C12 + OP1-OP3)

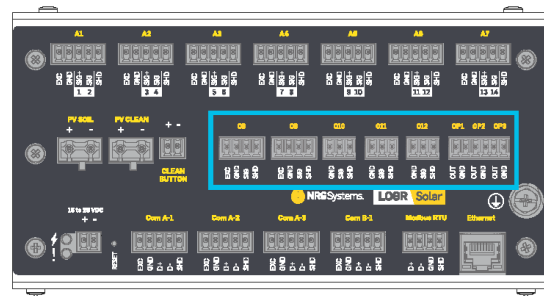
Page 5 of 5

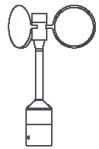
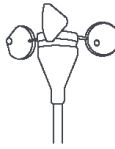
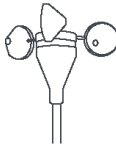
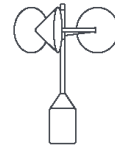
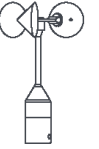
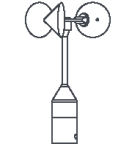
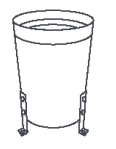
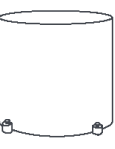
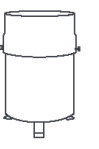
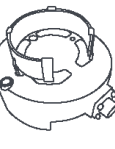
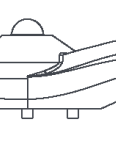

<p>NRG S1 Anemometer</p>  <p>Sensor Logger</p> <p>Red ■ EXC Blk ■ GND Wht □ SIG Shd SHD</p>	<p>NRG 40 Anemometer</p>  <p>Sensor Logger</p> <p>N/A EXC Blk ■ GND Wht □ SIG Shd SHD</p>	<p>NRG 40H</p>  <p>Sensor Logger</p> <p>Red ■ EXC Blk ■ GND Wht □ SIG Shd SHD</p>	<p>Thies FCA 4.3351</p>  <p>Sensor Logger</p> <p>Brn ■ EXC Grn ■ GND Wht □ SIG Shd SHD</p>
<p>WindSensor P2546C-OPR</p>  <p>Sensor Logger</p> <p>N/A EXC Brn ■ GND Wht □ SIG Shd SHD</p>	<p>WindSensor P2546D-OPR</p>  <p>Sensor Logger</p> <p>N/A EXC Brn ■ GND Wht □ SIG Shd SHD</p>	<p>NovaLynx 260 TBRG</p>  <p>Sensor Logger</p> <p>N/A EXC Blk ■ GND Red ■ SIG Shd SHD</p>	<p>Rainwise TBRG</p>  <p>Sensor Logger</p> <p>N/A EXC Blk ■ GND Red ■ SIG N/A SHD</p>
<p>Texas Elec. TR-525-W2S</p>  <p>Sensor Logger</p> <p>N/A EXC Wht □ GND Red ■ SIG N/A SHD</p>	<p>EKO MV01 Fan Speed</p>  <p>Sensor Logger</p> <p>Brn ■ EXC Blk ■ GND Blu ■ SIG N/A SHD</p>	<p>Kipp & Zonen CVF4 Fan</p>  <p>Sensor Logger</p> <p>Ylw ■ EXC Gry ■ GND Grn ■ SIG Shd SHD</p>	<p>RM Young Heated Rain Gauge</p>  <p>Sensor Logger</p> <p>Wht □ SIG Blk ■ GND</p>

6-16-24



Logger Data Acquisition

LOGR starts recording data and delivering it to the SCADA system as soon as it is powered up. A backup of all SCADA data is stored as internal memory on an embedded microSD card installed in the logger. If this data is needed as a backup or to send to NRG Technical Services for troubleshooting, it can be exported to the FTP server either with a command file or via the webserver. Alternatively, data can be manually exported locally without the aid of an FTP server (see [File Export](#) below).

Data File Transfer via FTP

A valid local FTP server should be set up so a *regularly scheduled* file transfer process can occur.

To configure an FTP, ensure that a **Command** directory and **Data** directory have been created. In each folder there should be a subfolder for each connected logger named as the last five digits of the serial number (ex. 00201 for SN 943200201).

1. Navigate to the **Logger** menu at the top of the page and select **File Transfer Settings** from the drop-down menu.
2. Change the **State** to *Enabled*.
3. Change the **Mode** to *Active* or *Passive* (based on server needs).
4. Check the boxes to enable *Commands* and *Data*.
5. Enter the necessary information including the local **FTP Server IP / URL**, **Username**, **Password**, **Command Directory Path** (e.g., /Vegahome/commands), and **Data Directory Path** (e.g., /Vegahome/data). The **FTP Command / Data Period (minutes)** determines the frequency that the local FTP is checked for commands.

Note that for this process to work correctly, the directories must be named “commands” and “data” respectively.

6. Click the yellow **Apply** button to save the changes.



FTP Configuration

State
 Enable Disabled

Mode
 Active Passive

Enabled Options
 Commands Data

FTP Server IP / URL

Username

Password
 Show Password

Command Directory Path

Data Directory Path

FTP Command / Data Period (minutes)

The logger is now configured to transfer to/from the local FTP server.



File Types

The files stored in the internal memory are a backup which can be used to backfill a SCADA database or for troubleshooting purposes. Much of the information stored in these files is available on the SCADA registers.

Data Files (*.dat)	<i>This file type contains time stamped logger data (one second, statistical or both) and human readable header text providing information regarding the logger configuration and site location.</i>
Diagnostic Files (*.diag)	<i>This file type contains statistical diagnostic data (voltages and currents) for troubleshooting purposes.</i>
Log Files (*.log)	<i>This file type contains a list of unix timestamped events and errors.</i>

Data File Types:

One-Second Data File	<i>Sends one second sensor data only.</i>
Statistical Data File	<i>Default option. Sends statistical data only.</i>
Both	<i>Sends two files, one of one-second data and one of statistical data. This also includes the Log and Diagnostic files.</i>

File Transfer Schedule

Below the FTP Configuration box, a daily scheduled transfer can be set to automatically send files to the FTP server. These are hourly files containing data (*.dat), diagnostic information (*.diag), and event logs (*.log). First, choose a specific time **When to Auto Send** the daily transfer and choose the **File Type** (see descriptions above). Click the yellow **Save** button to apply the configuration.

File Transfer Schedule

When to Auto Send

Never
 Send Once Daily at

File Type

One Second Data File
 Statistical Data File
 Both

Save



File Export

As of Firmware version 1.11.12, data files can be sent on demand, when needed, either to the configured FTP Server or via Direct Download. In the **File Export** box, select a *Start Date* and *End Date* for a range to retrieve data files. The *Start Date* must precede or equal the *End Date*. Matching dates will send only files from the chosen day. Files are stored for up to 90 days and the *Start Date* cannot be more than 90 days before the current date.

Select the *File Type* needed (see file type descriptions above) and click the yellow **FTP Transfer** button to send data to the configured FTP Server or click the yellow **Direct Download** button to save data locally. Diagnostic and log files are sent regardless of the data file type selected.

Note that to Direct Download files, a configured FTP must be **Disabled**, at least temporarily, during the download process. It can be re-enabled when the downloads have completed.

A progress message will pop up under the yellow download buttons. Files will be collected in your local Downloads folder.

Refrain from changing any settings on your device until the downloads are completed or until the download has been cancelled. If the page is navigated away from during the download process, please allow at least 1 minute to reload the page and begin downloading again.

The screenshot shows a web interface for file export. It has a title 'File Export' and two date pickers for 'Start Date' and 'End Date', both showing '01/31/2025'. Below the dates are three radio button options for 'File Type': 'One Second Data File', 'Statistical Data File' (which is selected), and 'Both'. At the bottom right of the form are two yellow buttons: 'FTP Transfer' and 'Direct Download'.

All exported files are human-readable and file names are formatted as:

YYYYMMDD_HHMM_XXXXX_ZZZZZ, where XXXXX is the LOGR serial number, and ZZZZZ is the index of the file.

For example, the file `20210801_2300_000214_000327.*` was created on August 1, 2021, at 11 PM, was logged by LOGR serial number 214, and has a file index number of 327. All files from that date and time have the same name and are followed by the appropriate file type extension (`*_onesecond.dat`, `*_statistical.dat`, `*.log`, `*.diag`).

Note that data retrieval by this method should be used only as needed or for backup of the SCADA system as file size is large.



SECTION 5 | COMMUNICATION & DATA

Modbus

Network & Data Flow

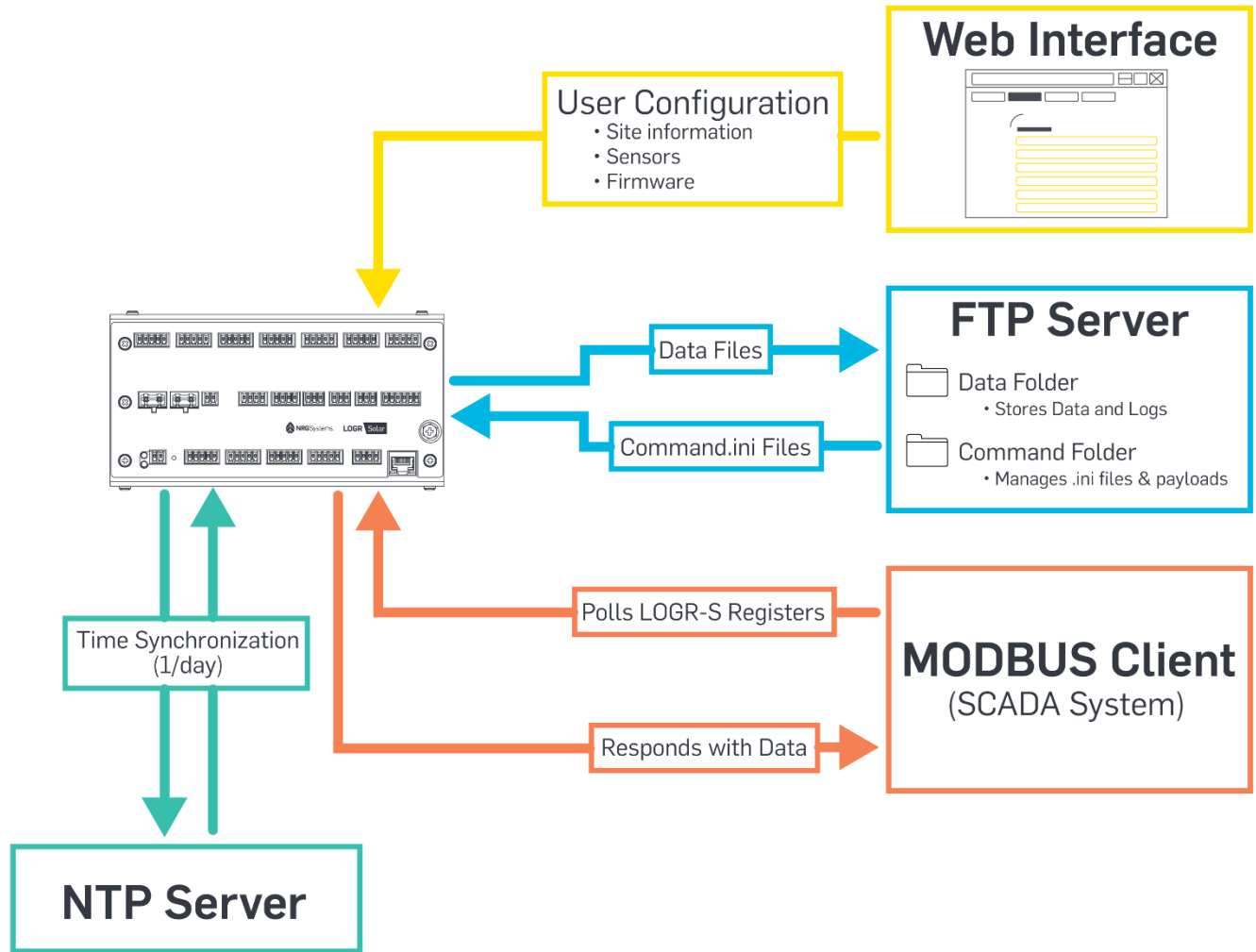



Modbus Demo Client

The Modbus Demo Client is a free desktop software utility that facilitates installation where configuration of the LOGR Modbus server is required. The utility allows the user to read real-time values from the LOGR registers and can establish and troubleshoot the proper connectivity of the measurement system.

Note that **LOGR 1.08** should be selected from the *Modbus Server Type* dropdown menu in the upper left corner of the window to view the correct Modbus map configuration.

Request Data	Address	Registers	Type	Duration (ms)
Configuration	0	88	Holding	
Analog Config 1	1000	120	Holding	
Analog Config 2	1120	120	Holding	
Analog Config 3	1240	40	Holding	
Serial Config 1	1280	120	Holding	
Serial Config 2	1400	120	Holding	
Serial Config 3	1520	120	Holding	
Serial Config 4	1640	120	Holding	
PSM Soiling	1806	34	Holding	
Soiling	10000	28	Holding	
Analog Scaled	10028	28	Holding	
Serial Scaled	10140	48	Holding	
Calculated Scaled	10236	20	Holding	

Address	Offset	Description	Value	Data Type	Source Hex
0	0	Map Version	0	UnsignedInteger32BitL	00 00 00 00
2	2	Float Format 12345678	0	FloatingPoint32BitL	00 00 00 00
4	4	UInt32 Format 123456789	0	UnsignedInteger32BitL	00 00 00 00
6	6	UInt16 Format 12345	0	UnsignedInteger32BitL	00 00 00 00
8	8	posix Time	0	UnsignedInteger32BitL	00 00 00 00
10	10	SD Card Free Space (KB)	0	UnsignedInteger32BitL	00 00 00 00
12	12	Serial Number	0	UnsignedInteger32BitL	00 00 00 00
14	14	Model Number	0	UnsignedInteger32BitL	00 00 00 00
16	16	Firmware CRC	0	UnsignedInteger32BitL	00 00 00 00
18	18	Firmware Version	0	UnsignedInteger32BitL	00 00 00 00
20	20	Boot Loader Version	0	UnsignedInteger32BitL	00 00 00 00
22	22	Boot Loader CRC	0	UnsignedInteger32BitL	00 00 00 00
24	24	System Up-time	0	UnsignedInteger32BitL	00 00 00 00
26	26	System Status 0	0	UnsignedInteger32BitL	00 00 00 00
28	28	System Status 1	0	UnsignedInteger32BitL	00 00 00 00
30	30	System Status 2	0	UnsignedInteger32BitL	00 00 00 00
32	32	System Status 3	0	UnsignedInteger32BitL	00 00 00 00

Access to the Modbus Demo Client is found here:

<https://www.nrgsystems.com/support/product-support/software/ipackaccess-modbus-client-demonstration-application>

See **Appendix B | Modbus Map**



Export File Format

Data collected and stored by the LOGR system is comprised of a sensor sample data file, a diagnostic data file, and an event log. This information is exported in a human-readable format as plain ASCII text.

A sensor sample data file consists of three sections:

- Unit configuration parameters
- Sensor description and channel configuration information
- Sensor sample data from enabled channels

Depending on the file export type selected, the sensor sample data section will contain either one second sample data or statistical data (see **File Types** section).

The screenshot shows a 'File Export' form with the following elements:

- Start Date:** A date input field containing '05 / 03 / 2022' with a calendar icon to its right.
- End Date:** A date input field containing '05 / 03 / 2022' with a calendar icon to its right.
- File Type:** Three radio button options: 'One Second Data File', 'Statistical Data File', and 'Both'. The 'Both' option is selected.
- Transfer:** A yellow button labeled 'Transfer' located in the bottom right corner of the form area.



Example exported data file:

<pre>NRG Systems Data Logger File Created On (UTC): 2023-10-13T16:00:03Z Model Number: 9432 Serial Number: 304 Created FW Version: 1.08.71</pre>	<p>Export timestamp LOGR Solar model number Unit serial number LOGR firmware version</p>	<p>Export File Header</p>
<pre>Site Properties Site: NRG Hinesburg Project: LOGR Solar Testing Location: NRG Roof Latitude: 44.33889 Longitude: -73.11202 Elevation: 136 Time Zone: -5</pre>	<p>Site and project details Time zone offset from UTC</p>	<p>LOGR Site Location Information</p>
<pre>File Properties File Schema Version: 1 SD Card Free Space (kB): 6660259 FTP FW Version: 1.08.71 File Content: One Second Samples Configuration Version: 4 Statistical Interval (min): 1</pre>	<p>File format version Remaining LOGR internal memory FTP firmware version Type of data within file Configuration structure version Data interval</p>	<p>Data File Information</p>
<pre>Sensor History Channel: 1 Description: NRG R1 Units: W/m^2 Serial Number: 945000133 Scale Factor: 111982.085938 Offset: 0.000000 Height: 0.00 Channel: 101 Client ID: 6 Sensor Type: Lufft WS600 Description: Lufft WS600 Measurand: Wind Speed Fast Units: m/s Serial Number: 000001 Scale Factor: 0.100000 Offset: 0.000000 Height: 0.00 Channel: 201 Soiling Ratio: Enabled Description: Soiling Ratio Index Units: NA Channel: 301 Description: Rainwise Daily Sum Units: mm Channel: 401 Description: NRG S1 Anemometer Units: m/s Serial Number: 9412006005 Scale Factor: 0.093500 Offset: 0.139000 Height: 0.00</pre>	<p>Analog channel configuration Serial channel configuration PV soiling channel configuration Calculated channel configuration Counter channel configuration</p>	<p>Channel Configuration Information</p>



Samples Only data file:

Sample_Timestamp	Ch1_Samples_hPa
2021-10-07T08:00:01Z	1012.6927
2021-10-07T08:00:02Z	1012.6984
2021-10-07T08:00:03Z	1012.6927
2021-10-07T08:00:04Z	1012.6959
2021-10-07T08:00:05Z	1012.6959
2021-10-07T08:00:06Z	1012.7005
2021-10-07T08:00:07Z	1012.6891
2021-10-07T08:00:08Z	1012.7057
2021-10-07T08:00:09Z	1012.7100
2021-10-07T08:00:10Z	1012.7057
2021-10-07T08:00:11Z	1012.7042
2021-10-07T08:00:12Z	1012.7100
2021-10-07T08:00:13Z	1012.7198
2021-10-07T08:00:14Z	1012.6990
2021-10-07T08:00:15Z	1012.6901
2021-10-07T08:00:16Z	1012.7036
2021-10-07T08:00:17Z	1012.6953
2021-10-07T08:00:18Z	1012.6964
2021-10-07T08:00:19Z	1012.7000
2021-10-07T08:00:20Z	1012.6922

Stats Only data file:

Stats_Timestamp	Ch1_Avg_hPa	Ch1_Min_hPa	Ch1_Max_hPa	Ch1_SD_hPa
2021-10-07T19:37:00Z	1009.6680	1009.6525	1009.6885	0.0073
2021-10-07T19:38:00Z	1009.6813	1009.6635	1009.6984	0.0083
2021-10-07T19:39:00Z	1009.6866	1009.6681	1009.6989	0.0066
2021-10-07T19:40:00Z	1009.6920	1009.6722	1009.7040	0.0068
2021-10-07T19:41:00Z	1009.6848	1009.6655	1009.7046	0.0079
2021-10-07T19:42:00Z	1009.6700	1009.6447	1009.6906	0.0100
2021-10-07T19:43:00Z	1009.6555	1009.6370	1009.6786	0.0083



Diagnostic data file format is also provided in plain text and consists of statistical data for MCU and analog sensor boards.

Diagnostic data for the MCU board:

- Raw power in
- 12.4V supply Voltage
- 12.4V supply current mA
- 3.3V supply voltage
- 3.3V supply current mA
- COM-A excitation voltage
- COM-A excitation current mA
- COM-B excitation voltage
- COM-B excitation current mA

Diagnostic data for the analog sensor board:

- +VIN Raw power
- 13.3V voltage
- 13.3V current mA
- 15V voltage
- 12V voltage
- 5V voltage
- -VIN Raw power
- 12V current mA



Event log file format is also provided in plain text and consists of information, activity, and fault events that could be useful to users and NRG technicians. A healthy LOGR unit will generate small event files. A typical full event file should look like the following:

```
1633635390, ACTION, SRVEL_ACT_DLGR_CREATING_NEW_PACKAGE_FILE, New Package: 70_1633635389_000201_001803.dat
1633635402, ACTION, SRVEL_ACT_ETH_INIT_START_FTP_CLIENT, Ethernet Init - Starting FTP Client
1633635402, INFO, SRVEL_INF_ETH_INIT_COMPLETE, Ethernet Initialization Complete
1633635403, ACTION, SRVEL_ACT_ETH_SNTP_TIME_UPDATED, SUBSYS_SNTP: NTP Time Adjusted by 4 seconds
1633635526, ACTION, SRVEL_ACT_ETH_START_DHCP_CLIENT, SUBSYS_ETHERNET: Eth Init - Starting DHCP Client....
1633635526, ACTION, SRVEL_ACT_ETH_DHCP_DISABLED_GETTING_IP_FROM_CFG, SUBSYS_ETH: DHCP disabled-getting IPAddress from cfg
1633635526, ACTION, SRVEL_ACT_ETH_INIT_START_DHCP_CLIENT, SUBSYS_ETHERNET: Eth Init - Starting DNS Client
1633635527, ACTION, SRVEL_ACT_ETH_INIT_START_SNTP_CLIENT, SUBSYS_ETHERNET: Eth Init - Starting SNTP Client
1633635527, ACTION, SRVEL_ACT_ETH_INIT_SNTP_CLIENT, SUBSYS_SNTP: Initializing Unicast Client
1633635527, INFO, SRVEL_INF_PRINTING_IP_ADDRESS, SNTP IP Address: 192.163.188. 77
1633635527, ACTION, SRVEL_ACT_ETH_STARTING_SNTP_CLIENT, SUBSYS_SNTP: Starting Unicast Client
1633635527, INFO, SRVEL_INF_ETH_WAITING_FOR_SNTP, SUBSYS_SNTP: Waiting 15 secs for server to respond
1633635536, ACTION, SRVEL_ACT_ETH_INIT_START_FTP_CLIENT, Ethernet Init - Starting FTP Client
1633635536, INFO, SRVEL_INF_ETH_INIT_COMPLETE, Ethernet Initialization Complete
1633635536, ACTION, SRVEL_ACT_ETH_SNTP_TIME_UPDATED, SUBSYS_SNTP: NTP Time Adjusted by -1 seconds|
```



SECTION 6 | POWER SYSTEMS

Powering the LOGR Logger

The LOGR data logger requires 16 to 28 VDC power. The logger typically draws 75 mA at 16 V (1.2 W) when unloaded.

Powering Sensors

LOGR also provides regulated 12 VDC power outputs at each serial sensor port and up to 50 mA per analog sensor port. It also provides up to 1000 mA shared between the three COM-A ports, plus up to 1000 mA to the COM-B port for serial connected sensors.

For power planning, simply add the sensor power requirements to the LOGR base power requirements to determine the power load of the relevant system. The maximum power load supported via LOGR is 2350 mA at 12 V. For power planning purposes, assume a maximum of 1.6 W (100 mA at 16 V) for the LOGR alone, for a total of 2450 mA at 12 V, or about 30 W total.

Note that the efficient power regulators in the LOGR will draw less current when input voltage is higher.

See the [Output Controls](#) section for further information regarding powering accessories such as external heaters and ventilators.

Grid-Tied Power Systems

When grid power is available, NRG has a power supply system preconfigured to fit the standard LOGR shelter box, sized to deliver up to 60 W of 16 VDC power.

Autonomous Power Systems

For installations without grid power, or when backup power is required, NRG can provide a preconfigured power solution for a specific installation, based on the proven power systems technology used in our SRM Systems. Please inquire with the NRG Sales Department and provide the following information:

- Location (latitude and longitude)
- Desired days of backup capacity (typically 1 to 5 days)
- Sensors, or sensor power requirements (Watts)



APPENDIX A | TECHNICAL SPECIFICATIONS

Please see nrgsystems.com for up-to-date product specifications.

Description	Instrument type	High utility data logger and real-time sensor interface
	Applications	Solar resource monitoring
Data Collection	Sampling interval	1 Hz (IEC 61724-1 compliant)
	Averaging interval	1-minute (IEC 61724-1 compliant)
	Real time clock	Internal battery-backed with time synchronization
	Storage medium	8 GB microSD
	Maximum data storage	90 days (all data with maximum configuration)
	Channel Capacity	<ul style="list-style-type: none"> • Fourteen (14) analog channels (single-ended); Seven (7) differential • Twenty-four (24) serial channels via two (2) RS-485 communication ports • Two (2) PV Input channels (soiling measurement) • Ten (10) calculated channels plus dedicated soiling ratio calculation • Five (5) counter channels (two with sensor excitation) • Three (3) outputs to control 12 V loads or relays
	Counter Channels Sensor Compatibility	<p>Compatible with a wide array of industry-standard anemometers including:</p> <ul style="list-style-type: none"> • NRG S1 or other opto anemometers • NRG 40C, Class 1, or compatible sine wave anemometers • Reed switch anemometers • Other frequency signals up to 2,500 Hz <p>Includes totalizer mode for Tipping Bucket Rain Gauge and other accumulator sensors</p> <p>Compatible with a wide array of sensors including:</p>
	Analog Channels Sensor Compatibility	<ul style="list-style-type: none"> • Standard analog sensors including NRG meteorological sensor suite (200M Wind Direction, T60 Temperature, BP60 Barometric Pressure, RH5X Relative Humidity, etc.) • Industry-standard pyranometers (Hukseflux SRxx series, EKO MS-xx series, Kipp & Zonen CMP series, etc.) • 10K NTC Thermistor and RTD (PT100, PT1000) type temperature sensors
	Analog Measurement Accuracy	<p>Uncertainty (k=2):</p> <ul style="list-style-type: none"> +/- 450 μV @ (-10 to +10) V +/- 61 μV @ (-1 to +1) V +/- 8.5 μV @ (-70 to +70) mV
	RS-485 Channels Sensor Compatibility	<p>Supports configurable Modbus RTU data acquisition. Contact NRG to discuss support for additional model types or protocols.</p> <ul style="list-style-type: none"> • Average • Standard deviation
	Parameters recorded for each channel	<ul style="list-style-type: none"> • Minimum/Maximum 1-sec sample • 3-second Wind gust
	Data delivery	<p>Note: Statistics reported on each channel are dependent on measurement type</p> <ul style="list-style-type: none"> • Real-time data delivery via Modbus registers (TCP via Ethernet or RTU via RS-485) • Scheduled delivery of historical data via FTP • On-demand transfer of historical data via internal web server to FTP
	Security	Password-protected web server access
Resolution	Analog measurement resolution	24-bit signed A/D conversion
Software	Type	<ul style="list-style-type: none"> • Onboard web server for logger configuration and administration • Modbus Demo Client to test configured unit prior to connecting to SCADA



Configuration	User interface	<ul style="list-style-type: none"> • Web-based user interface via Ethernet connected computing device with web browser (such as Google Chrome) • Recessed reset button on front panel • Audible beeper for user feedback
	Connections	<p>Integrated wiring panel featuring removable terminal blocks:</p> <ul style="list-style-type: none"> • Seven (7) dedicated analog sensor wiring ports • Four (4) dedicated RS-485 sensor wiring ports • Two (2) dedicated PV input ports • Five (5) Counter input ports • Four (4) Output ports • Enclosure ground lug connects to earth ground with included ground cable
Power requirements	Communication ports	<ul style="list-style-type: none"> • Ethernet port for web browser, FTP, Modbus TCP (server) • RS-485 port for Modbus RTU (server)
	Batteries	Coin cell battery for clock backup
	External power input	16 to 28 V DC
	External solar input	Contact NRG sales for accompanying backup power supply system options
Installation	External power output	<ul style="list-style-type: none"> • Constant 12 V source for powering analog sensors (50 mA per excitation port, 7 ports) • Constant 12 V source for powering modbus sensors (1000 mA shared by three COM-A ports and additional 1000mA to COM-B port) • Three (3) outputs to control external devices, 12 V DC (500 mA each, 1000 mA total maximum current)
	Mounting	35 mm DIN Rail
	Tools required	<ul style="list-style-type: none"> • Screwdriver for wiring input terminals (included) • Ethernet connected computing device with web browser (such as Google Chrome)
Environmental	Operating temperature range	-40 °C to 65 °C (-40 °F to 149 °F)
	Operating humidity range	<ul style="list-style-type: none"> • 0 to 100% relative humidity non-condensing • IP65 ingress protection with proper installation in NRG shelter box enclosure
Physical	Dimensions	(190.5 x 101.6 x 101.6) mm
Materials	Enclosure	Formed aluminum enclosure
Shipping	Shipping weight	0.91 kg (includes grounding wire and sensor plug set)



APPENDIX B | MODBUS MAP

Address	Offset	Description	Type
0	0	Map Version	UnsignedInteger32BitL
2	2	Float Format 12345678	FloatingPoint32BitL
4	4	UInt32 Format 123456789	UnsignedInteger32BitL
6	6	UInt16 Format 12345	UnsignedInteger32BitL
8	8	posix Time	UnsignedInteger32BitL
10	10	SD Card Free Space (KB)	UnsignedInteger32BitL
12	12	Serial Number	UnsignedInteger32BitL
14	14	Model Number	UnsignedInteger32BitL
16	16	Firmware CRC	UnsignedInteger32BitL
18	18	Firmware Version	UnsignedInteger32BitL
20	20	Boot Loader Version	UnsignedInteger32BitL
22	22	Boot Loader CRC	UnsignedInteger32BitL
24	24	System Up-time	UnsignedInteger32BitL
26	26	System Status 0	UnsignedInteger32BitL
28	28	System Status 1	UnsignedInteger32BitL
30	30	System Status 2	UnsignedInteger32BitL
32	32	System Status 3	UnsignedInteger32BitL
34	34	System Status 4	UnsignedInteger32BitL
36	36	System Status 5	UnsignedInteger32BitL
38	38	System Status 6	UnsignedInteger32BitL
40	40	System Status 7	UnsignedInteger32BitL
42	42	Slave Baud	UnsignedInteger32BitL
44	44	Slave Parity	UnsignedInteger32BitL
46	46	Slave Data Bits	UnsignedInteger32BitL
48	48	Slave Stop Bits	UnsignedInteger32BitL
50	50	Slave Address	UnsignedInteger32BitL
52	52	Master Baud 1	UnsignedInteger32BitL
54	54	Master Parity 1	UnsignedInteger32BitL
56	56	Master Data Bits 1	UnsignedInteger32BitL
58	58	Master Stop Bits 1	UnsignedInteger32BitL
60	60	Master Baud 2	UnsignedInteger32BitL
62	62	Master Parity 2	UnsignedInteger32BitL
64	64	Master Data Bits 2	UnsignedInteger32BitL
66	66	Master Stop Bits 2	UnsignedInteger32BitL
68	68	Net DHCP Enabled	UnsignedInteger32BitL
70	70	Cal Ref Voltage	UnsignedInteger32BitL
72	72	Card Config	UnsignedInteger32BitL
74	74	NTP Config	UnsignedInteger32BitL
76	76	Site Name	UnsignedInteger32BitL
78	78	Rollover Counter	UnsignedInteger32BitL
80	80	Latitude	FloatingPoint32BitL
82	82	Longitude	FloatingPoint32BitL



84	84	Elevation	FloatingPoint32BitL
86	86	Timezone Offset	FloatingPoint32BitL
1000	0	Analog Channel 1 Serial Number	UnsignedInteger32BitL
1002	2	Analog Channel 1 Serial Number	UnsignedInteger32BitL
1004	4	Analog Channel 1 Serial Number	UnsignedInteger32BitL
1006	6	Analog Channel 1 Serial Number	UnsignedInteger32BitL
1008	8	Analog Channel 1 Slope	FloatingPoint32BitL
1010	10	Analog Channel 1 Offset	FloatingPoint32BitL
1012	12	Analog Channel 1 Spare 1	FloatingPoint32BitL
1014	14	Analog Channel 1 Spare 2	FloatingPoint32BitL
1016	16	Analog Channel 1 Spare 3	FloatingPoint32BitL
1018	18	Analog Channel 1 Spare 4	FloatingPoint32BitL
1020	20	Analog Channel 2 Serial Number	UnsignedInteger32BitL
1022	22	Analog Channel 2 Serial Number	UnsignedInteger32BitL
1024	24	Analog Channel 2 Serial Number	UnsignedInteger32BitL
1026	26	Analog Channel 2 Serial Number	UnsignedInteger32BitL
1028	28	Analog Channel 2 Slope	FloatingPoint32BitL
1030	30	Analog Channel 2 Offset	FloatingPoint32BitL
1032	32	Analog Channel 2 Spare 1	FloatingPoint32BitL
1034	34	Analog Channel 2 Spare 2	FloatingPoint32BitL
1036	36	Analog Channel 2 Spare 3	FloatingPoint32BitL
1038	38	Analog Channel 2 Spare 4	FloatingPoint32BitL
1040	40	Analog Channel 3 Serial Number	UnsignedInteger32BitL
1042	42	Analog Channel 3 Serial Number	UnsignedInteger32BitL
1044	44	Analog Channel 3 Serial Number	UnsignedInteger32BitL
1046	46	Analog Channel 3 Serial Number	UnsignedInteger32BitL
1048	48	Analog Channel 3 Slope	FloatingPoint32BitL
1050	50	Analog Channel 3 Offset	FloatingPoint32BitL
1052	52	Analog Channel 3 Spare 1	FloatingPoint32BitL
1054	54	Analog Channel 3 Spare 2	FloatingPoint32BitL
1056	56	Analog Channel 3 Spare 3	FloatingPoint32BitL
1058	58	Analog Channel 3 Spare 4	FloatingPoint32BitL
1060	60	Analog Channel 4 Serial Number	UnsignedInteger32BitL
1062	62	Analog Channel 4 Serial Number	UnsignedInteger32BitL
1064	64	Analog Channel 4 Serial Number	UnsignedInteger32BitL
1066	66	Analog Channel 4 Serial Number	UnsignedInteger32BitL
1068	68	Analog Channel 4 Slope	FloatingPoint32BitL
1070	70	Analog Channel 4 Offset	FloatingPoint32BitL
1072	72	Analog Channel 4 Spare 1	FloatingPoint32BitL
1074	74	Analog Channel 4 Spare 2	FloatingPoint32BitL
1076	76	Analog Channel 4 Spare 3	FloatingPoint32BitL
1078	78	Analog Channel 4 Spare 4	FloatingPoint32BitL
1080	80	Analog Channel 5 Serial Number	UnsignedInteger32BitL
1082	82	Analog Channel 5 Serial Number	UnsignedInteger32BitL
1084	84	Analog Channel 5 Serial Number	UnsignedInteger32BitL



1086	86	Analog Channel 5 Serial Number	UnsignedInteger32BitL
1088	88	Analog Channel 5 Slope	FloatingPoint32BitL
1090	90	Analog Channel 5 Offset	FloatingPoint32BitL
1092	92	Analog Channel 5 Spare 1	FloatingPoint32BitL
1094	94	Analog Channel 5 Spare 2	FloatingPoint32BitL
1096	96	Analog Channel 5 Spare 3	FloatingPoint32BitL
1098	98	Analog Channel 5 Spare 4	FloatingPoint32BitL
1100	100	Analog Channel 6 Serial Number	UnsignedInteger32BitL
1102	102	Analog Channel 6 Serial Number	UnsignedInteger32BitL
1104	104	Analog Channel 6 Serial Number	UnsignedInteger32BitL
1106	106	Analog Channel 6 Serial Number	UnsignedInteger32BitL
1108	108	Analog Channel 6 Slope	FloatingPoint32BitL
1110	110	Analog Channel 6 Offset	FloatingPoint32BitL
1112	112	Analog Channel 6 Spare 1	FloatingPoint32BitL
1114	114	Analog Channel 6 Spare 2	FloatingPoint32BitL
1116	116	Analog Channel 6 Spare 3	FloatingPoint32BitL
1118	118	Analog Channel 6 Spare 4	FloatingPoint32BitL
1120	0	Analog Channel 6 Serial Number	UnsignedInteger32BitL
1122	2	Analog Channel 6 Serial Number	UnsignedInteger32BitL
1124	4	Analog Channel 6 Serial Number	UnsignedInteger32BitL
1126	6	Analog Channel 6 Serial Number	UnsignedInteger32BitL
1128	8	Analog Channel 6 Slope	FloatingPoint32BitL
1130	10	Analog Channel 6 Offset	FloatingPoint32BitL
1132	12	Analog Channel 6 Spare 1	FloatingPoint32BitL
1134	14	Analog Channel 6 Spare 2	FloatingPoint32BitL
1136	16	Analog Channel 6 Spare 3	FloatingPoint32BitL
1138	18	Analog Channel 6 Spare 4	FloatingPoint32BitL
1140	20	Analog Channel 7 Serial Number	UnsignedInteger32BitL
1142	22	Analog Channel 7 Serial Number	UnsignedInteger32BitL
1144	24	Analog Channel 7 Serial Number	UnsignedInteger32BitL
1146	26	Analog Channel 7 Serial Number	UnsignedInteger32BitL
1148	28	Analog Channel 7 Slope	FloatingPoint32BitL
1150	30	Analog Channel 7 Offset	FloatingPoint32BitL
1152	32	Analog Channel 7 Spare 1	FloatingPoint32BitL
1154	34	Analog Channel 7 Spare 2	FloatingPoint32BitL
1156	36	Analog Channel 7 Spare 3	FloatingPoint32BitL
1158	38	Analog Channel 7 Spare 4	FloatingPoint32BitL
1160	40	Analog Channel 8 Serial Number	UnsignedInteger32BitL
1162	42	Analog Channel 8 Serial Number	UnsignedInteger32BitL
1164	44	Analog Channel 8 Serial Number	UnsignedInteger32BitL
1166	46	Analog Channel 8 Serial Number	UnsignedInteger32BitL
1168	48	Analog Channel 8 Slope	FloatingPoint32BitL
1170	50	Analog Channel 8 Offset	FloatingPoint32BitL
1172	52	Analog Channel 8 Spare 1	FloatingPoint32BitL
1174	54	Analog Channel 8 Spare 2	FloatingPoint32BitL



1176	56	Analog Channel 8 Spare 3	FloatingPoint32BitL
1178	58	Analog Channel 8 Spare 4	FloatingPoint32BitL
1180	60	Analog Channel 9 Serial Number	UnsignedInteger32BitL
1182	62	Analog Channel 9 Serial Number	UnsignedInteger32BitL
1184	64	Analog Channel 9 Serial Number	UnsignedInteger32BitL
1186	66	Analog Channel 9 Serial Number	UnsignedInteger32BitL
1188	68	Analog Channel 9 Slope	FloatingPoint32BitL
1190	70	Analog Channel 9 Offset	FloatingPoint32BitL
1192	72	Analog Channel 9 Spare 1	FloatingPoint32BitL
1194	74	Analog Channel 9 Spare 2	FloatingPoint32BitL
1196	76	Analog Channel 9 Spare 3	FloatingPoint32BitL
1198	78	Analog Channel 9 Spare 4	FloatingPoint32BitL
1200	80	Analog Channel 10 Serial Number	UnsignedInteger32BitL
1202	82	Analog Channel 10 Serial Number	UnsignedInteger32BitL
1204	84	Analog Channel 10 Serial Number	UnsignedInteger32BitL
1206	86	Analog Channel 10 Serial Number	UnsignedInteger32BitL
1208	88	Analog Channel 10 Slope	FloatingPoint32BitL
1210	90	Analog Channel 10 Offset	FloatingPoint32BitL
1212	92	Analog Channel 10 Spare 1	FloatingPoint32BitL
1214	94	Analog Channel 10 Spare 2	FloatingPoint32BitL
1216	96	Analog Channel 10 Spare 3	FloatingPoint32BitL
1218	98	Analog Channel 10 Spare 4	FloatingPoint32BitL
1220	100	Analog Channel 11 Serial Number	UnsignedInteger32BitL
1222	102	Analog Channel 11 Serial Number	UnsignedInteger32BitL
1224	104	Analog Channel 11 Serial Number	UnsignedInteger32BitL
1226	106	Analog Channel 11 Serial Number	UnsignedInteger32BitL
1228	108	Analog Channel 11 Slope	FloatingPoint32BitL
1230	110	Analog Channel 11 Offset	FloatingPoint32BitL
1232	112	Analog Channel 11 Spare 1	FloatingPoint32BitL
1234	114	Analog Channel 11 Spare 2	FloatingPoint32BitL
1236	116	Analog Channel 11 Spare 3	FloatingPoint32BitL
1238	118	Analog Channel 11 Spare 4	FloatingPoint32BitL
1240	0	Analog Channel 12 Serial Number	UnsignedInteger32BitL
1242	2	Analog Channel 12 Serial Number	UnsignedInteger32BitL
1244	4	Analog Channel 12 Serial Number	UnsignedInteger32BitL
1246	6	Analog Channel 12 Serial Number	UnsignedInteger32BitL
1248	8	Analog Channel 12 Slope	FloatingPoint32BitL
1250	10	Analog Channel 12 Offset	FloatingPoint32BitL
1252	12	Analog Channel 12 Spare 1	FloatingPoint32BitL
1254	14	Analog Channel 12 Spare 2	FloatingPoint32BitL
1256	16	Analog Channel 12 Spare 3	FloatingPoint32BitL
1258	18	Analog Channel 12 Spare 4	FloatingPoint32BitL
1260	20	Analog Channel 13 Serial Number	UnsignedInteger32BitL
1262	22	Analog Channel 13 Serial Number	UnsignedInteger32BitL
1264	24	Analog Channel 13 Serial Number	UnsignedInteger32BitL



1266	26	Analog Channel 13 Serial Number	UnsignedInteger32BitL
1268	28	Analog Channel 13 Slope	FloatingPoint32BitL
1270	30	Analog Channel 13 Offset	FloatingPoint32BitL
1272	32	Analog Channel 13 Spare 1	FloatingPoint32BitL
1274	34	Analog Channel 13 Spare 2	FloatingPoint32BitL
1276	36	Analog Channel 13 Spare 3	FloatingPoint32BitL
1278	38	Analog Channel 13 Spare 4	FloatingPoint32BitL
1280	0	Serial Channel 1 Serial Number	UnsignedInteger32BitL
1282	2	Serial Channel 1 Serial Number	UnsignedInteger32BitL
1284	4	Serial Channel 1 Serial Number	UnsignedInteger32BitL
1286	6	Serial Channel 1 Serial Number	UnsignedInteger32BitL
1288	8	Serial Channel 1 Slope	FloatingPoint32BitL
1290	10	Serial Channel 1 Offset	FloatingPoint32BitL
1292	12	Serial Channel 1 Spare 1	FloatingPoint32BitL
1294	14	Serial Channel 1 Spare 2	FloatingPoint32BitL
1296	16	Serial Channel 1 Spare 3	FloatingPoint32BitL
1298	18	Serial Channel 1 Spare 4	FloatingPoint32BitL
1300	20	Serial Channel 2 Serial Number	UnsignedInteger32BitL
1302	22	Serial Channel 2 Serial Number	UnsignedInteger32BitL
1304	24	Serial Channel 2 Serial Number	UnsignedInteger32BitL
1306	26	Serial Channel 2 Serial Number	UnsignedInteger32BitL
1308	28	Serial Channel 2 Slope	FloatingPoint32BitL
1310	30	Serial Channel 2 Offset	FloatingPoint32BitL
1312	32	Serial Channel 2 Spare 1	FloatingPoint32BitL
1314	34	Serial Channel 2 Spare 2	FloatingPoint32BitL
1316	36	Serial Channel 2 Spare 3	FloatingPoint32BitL
1318	38	Serial Channel 2 Spare 4	FloatingPoint32BitL
1320	40	Serial Channel 3 Serial Number	UnsignedInteger32BitL
1322	42	Serial Channel 3 Serial Number	UnsignedInteger32BitL
1324	44	Serial Channel 3 Serial Number	UnsignedInteger32BitL
1326	46	Serial Channel 3 Serial Number	UnsignedInteger32BitL
1328	48	Serial Channel 3 Slope	FloatingPoint32BitL
1330	50	Serial Channel 3 Offset	FloatingPoint32BitL
1332	52	Serial Channel 3 Spare 1	FloatingPoint32BitL
1334	54	Serial Channel 3 Spare 2	FloatingPoint32BitL
1336	56	Serial Channel 3 Spare 3	FloatingPoint32BitL
1338	58	Serial Channel 3 Spare 4	FloatingPoint32BitL
1340	60	Serial Channel 4 Serial Number	UnsignedInteger32BitL
1342	62	Serial Channel 4 Serial Number	UnsignedInteger32BitL
1344	64	Serial Channel 4 Serial Number	UnsignedInteger32BitL
1346	66	Serial Channel 4 Serial Number	UnsignedInteger32BitL
1348	68	Serial Channel 4 Slope	FloatingPoint32BitL
1350	70	Serial Channel 4 Offset	FloatingPoint32BitL
1352	72	Serial Channel 4 Spare 1	FloatingPoint32BitL
1354	74	Serial Channel 4 Spare 2	FloatingPoint32BitL



1356	76	Serial Channel 4 Spare 3	FloatingPoint32BitL
1358	78	Serial Channel 4 Spare 4	FloatingPoint32BitL
1360	80	Serial Channel 5 Serial Number	UnsignedInteger32BitL
1362	82	Serial Channel 5 Serial Number	UnsignedInteger32BitL
1364	84	Serial Channel 5 Serial Number	UnsignedInteger32BitL
1366	86	Serial Channel 5 Serial Number	UnsignedInteger32BitL
1368	88	Serial Channel 5 Slope	FloatingPoint32BitL
1370	90	Serial Channel 5 Offset	FloatingPoint32BitL
1372	92	Serial Channel 5 Spare 1	FloatingPoint32BitL
1374	94	Serial Channel 5 Spare 2	FloatingPoint32BitL
1376	96	Serial Channel 5 Spare 3	FloatingPoint32BitL
1378	98	Serial Channel 5 Spare 4	FloatingPoint32BitL
1380	100	Serial Channel 6 Serial Number	UnsignedInteger32BitL
1382	102	Serial Channel 6 Serial Number	UnsignedInteger32BitL
1384	104	Serial Channel 6 Serial Number	UnsignedInteger32BitL
1386	106	Serial Channel 6 Serial Number	UnsignedInteger32BitL
1388	108	Serial Channel 6 Slope	FloatingPoint32BitL
1390	110	Serial Channel 6 Offset	FloatingPoint32BitL
1392	112	Serial Channel 6 Spare 1	FloatingPoint32BitL
1394	114	Serial Channel 6 Spare 2	FloatingPoint32BitL
1396	116	Serial Channel 6 Spare 3	FloatingPoint32BitL
1398	118	Serial Channel 6 Spare 4	FloatingPoint32BitL
1400	0	Serial Channel 6 Serial Number	UnsignedInteger32BitL
1402	2	Serial Channel 6 Serial Number	UnsignedInteger32BitL
1404	4	Serial Channel 6 Serial Number	UnsignedInteger32BitL
1406	6	Serial Channel 6 Serial Number	UnsignedInteger32BitL
1408	8	Serial Channel 6 Slope	FloatingPoint32BitL
1410	10	Serial Channel 6 Offset	FloatingPoint32BitL
1412	12	Serial Channel 6 Spare 1	FloatingPoint32BitL
1414	14	Serial Channel 6 Spare 2	FloatingPoint32BitL
1416	16	Serial Channel 6 Spare 3	FloatingPoint32BitL
1418	18	Serial Channel 6 Spare 4	FloatingPoint32BitL
1420	20	Serial Channel 7 Serial Number	UnsignedInteger32BitL
1422	22	Serial Channel 7 Serial Number	UnsignedInteger32BitL
1424	24	Serial Channel 7 Serial Number	UnsignedInteger32BitL
1426	26	Serial Channel 7 Serial Number	UnsignedInteger32BitL
1428	28	Serial Channel 7 Slope	FloatingPoint32BitL
1430	30	Serial Channel 7 Offset	FloatingPoint32BitL
1432	32	Serial Channel 7 Spare 1	FloatingPoint32BitL
1434	34	Serial Channel 7 Spare 2	FloatingPoint32BitL
1436	36	Serial Channel 7 Spare 3	FloatingPoint32BitL
1438	38	Serial Channel 7 Spare 4	FloatingPoint32BitL
1440	40	Serial Channel 8 Serial Number	UnsignedInteger32BitL
1442	42	Serial Channel 8 Serial Number	UnsignedInteger32BitL
1444	44	Serial Channel 8 Serial Number	UnsignedInteger32BitL



1446	46	Serial Channel 8 Serial Number	UnsignedInteger32BitL
1448	48	Serial Channel 8 Slope	FloatingPoint32BitL
1450	50	Serial Channel 8 Offset	FloatingPoint32BitL
1452	52	Serial Channel 8 Spare 1	FloatingPoint32BitL
1454	54	Serial Channel 8 Spare 2	FloatingPoint32BitL
1456	56	Serial Channel 8 Spare 3	FloatingPoint32BitL
1458	58	Serial Channel 8 Spare 4	FloatingPoint32BitL
1460	60	Serial Channel 9 Serial Number	UnsignedInteger32BitL
1462	62	Serial Channel 9 Serial Number	UnsignedInteger32BitL
1464	64	Serial Channel 9 Serial Number	UnsignedInteger32BitL
1466	66	Serial Channel 9 Serial Number	UnsignedInteger32BitL
1468	68	Serial Channel 9 Slope	FloatingPoint32BitL
1470	70	Serial Channel 9 Offset	FloatingPoint32BitL
1472	72	Serial Channel 9 Spare 1	FloatingPoint32BitL
1474	74	Serial Channel 9 Spare 2	FloatingPoint32BitL
1476	76	Serial Channel 9 Spare 3	FloatingPoint32BitL
1478	78	Serial Channel 9 Spare 4	FloatingPoint32BitL
1480	80	Serial Channel 10 Serial Number	UnsignedInteger32BitL
1482	82	Serial Channel 10 Serial Number	UnsignedInteger32BitL
1484	84	Serial Channel 10 Serial Number	UnsignedInteger32BitL
1486	86	Serial Channel 10 Serial Number	UnsignedInteger32BitL
1488	88	Serial Channel 10 Slope	FloatingPoint32BitL
1490	90	Serial Channel 10 Offset	FloatingPoint32BitL
1492	92	Serial Channel 10 Spare 1	FloatingPoint32BitL
1494	94	Serial Channel 10 Spare 2	FloatingPoint32BitL
1496	96	Serial Channel 10 Spare 3	FloatingPoint32BitL
1498	98	Serial Channel 10 Spare 4	FloatingPoint32BitL
1500	100	Serial Channel 11 Serial Number	UnsignedInteger32BitL
1502	102	Serial Channel 11 Serial Number	UnsignedInteger32BitL
1504	104	Serial Channel 11 Serial Number	UnsignedInteger32BitL
1506	106	Serial Channel 11 Serial Number	UnsignedInteger32BitL
1508	108	Serial Channel 11 Slope	FloatingPoint32BitL
1510	110	Serial Channel 11 Offset	FloatingPoint32BitL
1512	112	Serial Channel 11 Spare 1	FloatingPoint32BitL
1514	114	Serial Channel 11 Spare 2	FloatingPoint32BitL
1516	116	Serial Channel 11 Spare 3	FloatingPoint32BitL
1518	118	Serial Channel 11 Spare 4	FloatingPoint32BitL
1520	0	Serial Channel 13 Serial Number	UnsignedInteger32BitL
1522	2	Serial Channel 13 Serial Number	UnsignedInteger32BitL
1524	4	Serial Channel 13 Serial Number	UnsignedInteger32BitL
1526	6	Serial Channel 13 Serial Number	UnsignedInteger32BitL
1528	8	Serial Channel 13 Slope	FloatingPoint32BitL
1530	10	Serial Channel 13 Offset	FloatingPoint32BitL
1532	12	Serial Channel 13 Spare 1	FloatingPoint32BitL
1534	14	Serial Channel 13 Spare 2	FloatingPoint32BitL



1536	16	Serial Channel 13 Spare 3	FloatingPoint32BitL
1538	18	Serial Channel 13 Spare 4	FloatingPoint32BitL
1540	20	Serial Channel 14 Serial Number	UnsignedInteger32BitL
1542	22	Serial Channel 14 Serial Number	UnsignedInteger32BitL
1544	24	Serial Channel 14 Serial Number	UnsignedInteger32BitL
1546	26	Serial Channel 14 Serial Number	UnsignedInteger32BitL
1548	28	Serial Channel 14 Slope	FloatingPoint32BitL
1550	30	Serial Channel 14 Offset	FloatingPoint32BitL
1552	32	Serial Channel 14 Spare 1	FloatingPoint32BitL
1554	34	Serial Channel 14 Spare 2	FloatingPoint32BitL
1556	36	Serial Channel 14 Spare 3	FloatingPoint32BitL
1558	38	Serial Channel 14 Spare 4	FloatingPoint32BitL
1560	40	Serial Channel 15 Serial Number	UnsignedInteger32BitL
1562	42	Serial Channel 15 Serial Number	UnsignedInteger32BitL
1564	44	Serial Channel 15 Serial Number	UnsignedInteger32BitL
1566	46	Serial Channel 15 Serial Number	UnsignedInteger32BitL
1568	48	Serial Channel 15 Slope	FloatingPoint32BitL
1570	50	Serial Channel 15 Offset	FloatingPoint32BitL
1572	52	Serial Channel 15 Spare 1	FloatingPoint32BitL
1574	54	Serial Channel 15 Spare 2	FloatingPoint32BitL
1576	56	Serial Channel 15 Spare 3	FloatingPoint32BitL
1578	58	Serial Channel 15 Spare 4	FloatingPoint32BitL
1580	60	Serial Channel 16 Serial Number	UnsignedInteger32BitL
1582	62	Serial Channel 16 Serial Number	UnsignedInteger32BitL
1584	64	Serial Channel 16 Serial Number	UnsignedInteger32BitL
1586	66	Serial Channel 16 Serial Number	UnsignedInteger32BitL
1588	68	Serial Channel 16 Slope	FloatingPoint32BitL
1590	70	Serial Channel 16 Offset	FloatingPoint32BitL
1592	72	Serial Channel 16 Spare 1	FloatingPoint32BitL
1594	74	Serial Channel 16 Spare 2	FloatingPoint32BitL
1596	76	Serial Channel 16 Spare 3	FloatingPoint32BitL
1598	78	Serial Channel 16 Spare 4	FloatingPoint32BitL
1600	80	Serial Channel 17 Serial Number	UnsignedInteger32BitL
1602	82	Serial Channel 17 Serial Number	UnsignedInteger32BitL
1604	84	Serial Channel 17 Serial Number	UnsignedInteger32BitL
1606	86	Serial Channel 17 Serial Number	UnsignedInteger32BitL
1608	88	Serial Channel 17 Slope	FloatingPoint32BitL
1610	90	Serial Channel 17 Offset	FloatingPoint32BitL
1612	92	Serial Channel 17 Spare 1	FloatingPoint32BitL
1614	94	Serial Channel 17 Spare 2	FloatingPoint32BitL
1616	96	Serial Channel 17 Spare 3	FloatingPoint32BitL
1618	98	Serial Channel 17 Spare 4	FloatingPoint32BitL
1620	100	Serial Channel 18 Serial Number	UnsignedInteger32BitL
1622	102	Serial Channel 18 Serial Number	UnsignedInteger32BitL
1624	104	Serial Channel 18 Serial Number	UnsignedInteger32BitL



1626	106	Serial Channel 18 Serial Number	UnsignedInteger32BitL
1628	108	Serial Channel 18 Slope	FloatingPoint32BitL
1630	110	Serial Channel 18 Offset	FloatingPoint32BitL
1632	112	Serial Channel 18 Spare 1	FloatingPoint32BitL
1634	114	Serial Channel 18 Spare 2	FloatingPoint32BitL
1636	116	Serial Channel 18 Spare 3	FloatingPoint32BitL
1638	118	Serial Channel 18 Spare 4	FloatingPoint32BitL
1640	0	Serial Channel 19 Serial Number	UnsignedInteger32BitL
1642	2	Serial Channel 19 Serial Number	UnsignedInteger32BitL
1644	4	Serial Channel 19 Serial Number	UnsignedInteger32BitL
1646	6	Serial Channel 19 Serial Number	UnsignedInteger32BitL
1648	8	Serial Channel 19 Slope	FloatingPoint32BitL
1650	10	Serial Channel 19 Offset	FloatingPoint32BitL
1652	12	Serial Channel 19 Spare 1	FloatingPoint32BitL
1654	14	Serial Channel 19 Spare 2	FloatingPoint32BitL
1656	16	Serial Channel 19 Spare 3	FloatingPoint32BitL
1658	18	Serial Channel 19 Spare 4	FloatingPoint32BitL
1660	20	Serial Channel 20 Serial Number	UnsignedInteger32BitL
1662	22	Serial Channel 20 Serial Number	UnsignedInteger32BitL
1664	24	Serial Channel 20 Serial Number	UnsignedInteger32BitL
1666	26	Serial Channel 20 Serial Number	UnsignedInteger32BitL
1668	28	Serial Channel 20 Slope	FloatingPoint32BitL
1670	30	Serial Channel 20 Offset	FloatingPoint32BitL
1672	32	Serial Channel 20 Spare 1	FloatingPoint32BitL
1674	34	Serial Channel 20 Spare 2	FloatingPoint32BitL
1676	36	Serial Channel 20 Spare 3	FloatingPoint32BitL
1678	38	Serial Channel 20 Spare 4	FloatingPoint32BitL
1680	40	Serial Channel 21 Serial Number	UnsignedInteger32BitL
1682	42	Serial Channel 21 Serial Number	UnsignedInteger32BitL
1684	44	Serial Channel 21 Serial Number	UnsignedInteger32BitL
1686	46	Serial Channel 21 Serial Number	UnsignedInteger32BitL
1688	48	Serial Channel 21 Slope	FloatingPoint32BitL
1690	50	Serial Channel 21 Offset	FloatingPoint32BitL
1692	52	Serial Channel 21 Spare 1	FloatingPoint32BitL
1694	54	Serial Channel 21 Spare 2	FloatingPoint32BitL
1696	56	Serial Channel 21 Spare 3	FloatingPoint32BitL
1698	58	Serial Channel 21 Spare 4	FloatingPoint32BitL
1700	60	Serial Channel 22 Serial Number	UnsignedInteger32BitL
1702	62	Serial Channel 22 Serial Number	UnsignedInteger32BitL
1704	64	Serial Channel 22 Serial Number	UnsignedInteger32BitL
1706	66	Serial Channel 22 Serial Number	UnsignedInteger32BitL
1708	68	Serial Channel 22 Slope	FloatingPoint32BitL
1710	70	Serial Channel 22 Offset	FloatingPoint32BitL
1712	72	Serial Channel 22 Spare 1	FloatingPoint32BitL
1714	74	Serial Channel 22 Spare 2	FloatingPoint32BitL



1716	76	Serial Channel 22 Spare 3	FloatingPoint32BitL
1718	78	Serial Channel 22 Spare 4	FloatingPoint32BitL
1720	80	Serial Channel 23 Serial Number	UnsignedInteger32BitL
1722	82	Serial Channel 23 Serial Number	UnsignedInteger32BitL
1724	84	Serial Channel 23 Serial Number	UnsignedInteger32BitL
1726	86	Serial Channel 23 Serial Number	UnsignedInteger32BitL
1728	88	Serial Channel 23 Slope	FloatingPoint32BitL
1730	90	Serial Channel 23 Offset	FloatingPoint32BitL
1732	92	Serial Channel 23 Spare 1	FloatingPoint32BitL
1734	94	Serial Channel 23 Spare 2	FloatingPoint32BitL
1736	96	Serial Channel 23 Spare 3	FloatingPoint32BitL
1738	98	Serial Channel 23 Spare 4	FloatingPoint32BitL
1740	100	Serial Channel 24 Serial Number	UnsignedInteger32BitL
1742	102	Serial Channel 24 Serial Number	UnsignedInteger32BitL
1744	104	Serial Channel 24 Serial Number	UnsignedInteger32BitL
1746	106	Serial Channel 24 Serial Number	UnsignedInteger32BitL
1748	108	Serial Channel 24 Slope	FloatingPoint32BitL
1750	110	Serial Channel 24 Offset	FloatingPoint32BitL
1752	112	Serial Channel 24 Spare 1	FloatingPoint32BitL
1754	114	Serial Channel 24 Spare 2	FloatingPoint32BitL
1756	116	Serial Channel 24 Spare 3	FloatingPoint32BitL
1758	118	Serial Channel 24 Spare 4	FloatingPoint32BitL
1804	0	Effective Irradiance Soil (G_SOIL) channel 212	FloatingPoint32BitL
1806	2	Effective Irradiance Clean (G) channel 209	FloatingPoint32BitL
1808	4	Soiling Ratio Isc Index (SRIsc) channel 210	FloatingPoint32BitL
1810	6	Daily Soiling Ratio channel 211	FloatingPoint32BitL
1812	8	Temp coefficient of Isc_Clean (%)	FloatingPoint32BitL
1814	10	Temp coefficient of Isc_Soil (%)	FloatingPoint32BitL
1816	12	Temp coefficient of Voc_Clean (%)	FloatingPoint32BitL
1818	14	Temp coefficient of Voc_Soil (%)	FloatingPoint32BitL
1820	16	STC Irradiance	FloatingPoint32BitL
1822	18	STC Temperature	FloatingPoint32BitL
1824	20	PV Clean Isc at STC	FloatingPoint32BitL
1826	22	PV Soil Isc at STC	FloatingPoint32BitL
1828	24	Minimum Irradiance G to include	FloatingPoint32BitL
1830	26	Number of Data Points for day	UnsignedInteger32BitL
1832	28	Minutes to each side solar noon	UnsignedInteger32BitL
1834	30	Solar Noon Hour	UnsignedInteger32BitL
1836	32	Solar Noon Minute	UnsignedInteger32BitL
1838	34	Method	UnsignedInteger32BitL
10000	0	Year UTC	UnsignedInteger32BitL
10002	2	Month UTC	UnsignedInteger32BitL
10004	4	Day UTC	UnsignedInteger32BitL
10006	6	Hour UTC	UnsignedInteger32BitL
10008	8	Minute UTC	UnsignedInteger32BitL



10010	10	Second UTC	UnsignedInteger32BitL
10012	12	iShortCircuitClean channel 202	FloatingPoint32BitL
10014	14	vOpenCircuitClean channel 203	FloatingPoint32BitL
10016	16	iShortCircuitSoil channel 204	FloatingPoint32BitL
10018	18	vOpenCircuitSoil channel 205	FloatingPoint32BitL
10020	20	unused	FloatingPoint32BitL
10022	22	unused	FloatingPoint32BitL
10024	24	Soiling Ratio channel 201	FloatingPoint32BitL
10026	26	Clean Time	UnsignedInteger32BitL
10028	0	Analog Scaled Channel 1	FloatingPoint32BitL
10030	2	Analog Scaled Channel 2	FloatingPoint32BitL
10032	4	Analog Scaled Channel 3	FloatingPoint32BitL
10034	6	Analog Scaled Channel 4	FloatingPoint32BitL
10036	8	Analog Scaled Channel 5	FloatingPoint32BitL
10038	10	Analog Scaled Channel 6	FloatingPoint32BitL
10040	12	Analog Scaled Channel 7	FloatingPoint32BitL
10042	14	Analog Scaled Channel 8	FloatingPoint32BitL
10044	16	Analog Scaled Channel 9	FloatingPoint32BitL
10046	18	Analog Scaled Channel 10	FloatingPoint32BitL
10048	20	Analog Scaled Channel 11	FloatingPoint32BitL
10050	22	Analog Scaled Channel 12	FloatingPoint32BitL
10052	24	Analog Scaled Channel 13	FloatingPoint32BitL
10054	26	Analog Scaled Channel 14	FloatingPoint32BitL
10140	0	Serial Scaled Channel 101	FloatingPoint32BitL
10142	2	Serial Scaled Channel 102	FloatingPoint32BitL
10144	4	Serial Scaled Channel 103	FloatingPoint32BitL
10146	6	Serial Scaled Channel 104	FloatingPoint32BitL
10148	8	Serial Scaled Channel 105	FloatingPoint32BitL
10150	10	Serial Scaled Channel 106	FloatingPoint32BitL
10152	12	Serial Scaled Channel 107	FloatingPoint32BitL
10154	14	Serial Scaled Channel 108	FloatingPoint32BitL
10156	16	Serial Scaled Channel 109	FloatingPoint32BitL
10158	18	Serial Scaled Channel 110	FloatingPoint32BitL
10160	20	Serial Scaled Channel 111	FloatingPoint32BitL
10162	22	Serial Scaled Channel 112	FloatingPoint32BitL
10164	24	Serial Scaled Channel 113	FloatingPoint32BitL
10166	26	Serial Scaled Channel 114	FloatingPoint32BitL
10168	28	Serial Scaled Channel 115	FloatingPoint32BitL
10170	30	Serial Scaled Channel 116	FloatingPoint32BitL
10172	32	Serial Scaled Channel 117	FloatingPoint32BitL
10174	34	Serial Scaled Channel 118	FloatingPoint32BitL
10176	36	Serial Scaled Channel 119	FloatingPoint32BitL
10178	38	Serial Scaled Channel 120	FloatingPoint32BitL
10180	40	Serial Scaled Channel 121	FloatingPoint32BitL
10182	42	Serial Scaled Channel 122	FloatingPoint32BitL



10184	44	Serial Scaled Channel 123	FloatingPoint32BitL
10186	46	Serial Scaled Channel 124	FloatingPoint32BitL
10236	0	Calculated Scaled Channel 301	FloatingPoint32BitL
10238	2	Calculated Scaled Channel 302	FloatingPoint32BitL
10240	4	Calculated Scaled Channel 303	FloatingPoint32BitL
10242	6	Calculated Scaled Channel 304	FloatingPoint32BitL
10244	8	Calculated Scaled Channel 305	FloatingPoint32BitL
10246	10	Calculated Scaled Channel 306	FloatingPoint32BitL
10248	12	Calculated Scaled Channel 307	FloatingPoint32BitL
10250	14	Calculated Scaled Channel 308	FloatingPoint32BitL
10252	16	Calculated Scaled Channel 309	FloatingPoint32BitL
10254	18	Calculated Scaled Channel 310	FloatingPoint32BitL
10372	0	Counter channel scaled data 401	FloatingPoint32BitL
10374	2	Counter channel scaled data 402	FloatingPoint32BitL
10376	4	Counter channel scaled data 403	FloatingPoint32BitL
10378	6	Counter channel scaled data 404	FloatingPoint32BitL
10380	8	Counter channel scaled data 405	FloatingPoint32BitL
10428	0	Counter board Overcurrent Faulted	UnsignedInteger32BitL
10430	0	OP1 is active	UnsignedInteger32BitL
10432	2	OP2 is active	UnsignedInteger32BitL
10434	4	OP3 is active	UnsignedInteger32BitL
15000	0	Year UTC	UnsignedInteger32BitL
15002	2	Month UTC	UnsignedInteger32BitL
15004	4	Day UTC	UnsignedInteger32BitL
15006	6	Hour UTC	UnsignedInteger32BitL
15008	8	Minute UTC	UnsignedInteger32BitL
15010	10	Second UTC	UnsignedInteger32BitL
15012	12	Analog Stats Channel 1 Average	FloatingPoint32BitL
15014	14	Analog Stats Channel 1 Min	FloatingPoint32BitL
15016	16	Analog Stats Channel 1 Max	FloatingPoint32BitL
15018	18	Analog Stats Channel 1 SD	FloatingPoint32BitL
15020	20	Analog Stats Channel 1 Gust or Gust Dir	FloatingPoint32BitL
15022	22	Analog Stats Channel 2 Average	FloatingPoint32BitL
15024	24	Analog Stats Channel 2 Min	FloatingPoint32BitL
15026	26	Analog Stats Channel 2 Max	FloatingPoint32BitL
15028	28	Analog Stats Channel 2 SD	FloatingPoint32BitL
15030	30	Analog Stats Channel 2 Gust or Gust Dir	FloatingPoint32BitL
15032	32	Analog Stats Channel 3 Average	FloatingPoint32BitL
15034	34	Analog Stats Channel 3 Min	FloatingPoint32BitL
15036	36	Analog Stats Channel 3 Max	FloatingPoint32BitL
15038	38	Analog Stats Channel 3 SD	FloatingPoint32BitL
15040	40	Analog Stats Channel 3 Gust or Gust Dir	FloatingPoint32BitL
15042	42	Analog Stats Channel 4 Average	FloatingPoint32BitL
15044	44	Analog Stats Channel 4 Min	FloatingPoint32BitL
15046	46	Analog Stats Channel 4 Max	FloatingPoint32BitL



15048	48	Analog Stats Channel 4 SD	FloatingPoint32BitL
15050	50	Analog Stats Channel 4 Gust or Gust Dir	FloatingPoint32BitL
15052	52	Analog Stats Channel 5 Average	FloatingPoint32BitL
15054	54	Analog Stats Channel 5 Min	FloatingPoint32BitL
15056	56	Analog Stats Channel 5 Max	FloatingPoint32BitL
15058	58	Analog Stats Channel 5 SD	FloatingPoint32BitL
15060	60	Analog Stats Channel 5 Gust or Gust Dir	FloatingPoint32BitL
15062	62	Analog Stats Channel 6 Average	FloatingPoint32BitL
15064	64	Analog Stats Channel 6 Min	FloatingPoint32BitL
15066	66	Analog Stats Channel 6 Max	FloatingPoint32BitL
15068	68	Analog Stats Channel 6 SD	FloatingPoint32BitL
15070	70	Analog Stats Channel 6 Gust or Gust Dir	FloatingPoint32BitL
15072	72	Analog Stats Channel 7 Average	FloatingPoint32BitL
15074	74	Analog Stats Channel 7 Min	FloatingPoint32BitL
15076	76	Analog Stats Channel 7 Max	FloatingPoint32BitL
15078	78	Analog Stats Channel 7 SD	FloatingPoint32BitL
15080	80	Analog Stats Channel 7 Gust or Gust Dir	FloatingPoint32BitL
15082	82	Analog Stats Channel 8 Average	FloatingPoint32BitL
15084	84	Analog Stats Channel 8 Min	FloatingPoint32BitL
15086	86	Analog Stats Channel 8 Max	FloatingPoint32BitL
15088	88	Analog Stats Channel 8 SD	FloatingPoint32BitL
15090	90	Analog Stats Channel 8 Gust or Gust Dir	FloatingPoint32BitL
15092	92	Analog Stats Channel 9 Average	FloatingPoint32BitL
15094	94	Analog Stats Channel 9 Min	FloatingPoint32BitL
15096	96	Analog Stats Channel 9 Max	FloatingPoint32BitL
15098	98	Analog Stats Channel 9 SD	FloatingPoint32BitL
15100	100	Analog Stats Channel 9 Gust or Gust Dir	FloatingPoint32BitL
15102	102	Analog Stats Channel 10 Average	FloatingPoint32BitL
15104	104	Analog Stats Channel 10 Min	FloatingPoint32BitL
15106	106	Analog Stats Channel 10 Max	FloatingPoint32BitL
15108	108	Analog Stats Channel 10 SD	FloatingPoint32BitL
15110	110	Analog Stats Channel 10 Gust or Gust Dir	FloatingPoint32BitL
15112	112	Analog Stats Channel 11 Average	FloatingPoint32BitL
15114	114	Analog Stats Channel 11 Min	FloatingPoint32BitL
15116	116	Analog Stats Channel 11 Max	FloatingPoint32BitL
15118	118	Analog Stats Channel 11 SD	FloatingPoint32BitL
15120	120	Analog Stats Channel 11 Gust or Gust Dir	FloatingPoint32BitL
15122	0	Analog Stats Channel 12 Average	FloatingPoint32BitL
15124	2	Analog Stats Channel 12 Min	FloatingPoint32BitL
15126	4	Analog Stats Channel 12 Max	FloatingPoint32BitL
15128	6	Analog Stats Channel 12 SD	FloatingPoint32BitL
15130	8	Analog Stats Channel 12 Gust or Gust Dir	FloatingPoint32BitL
15132	10	Analog Stats Channel 13 Average	FloatingPoint32BitL
15134	12	Analog Stats Channel 13 Min	FloatingPoint32BitL
15136	14	Analog Stats Channel 13 Max	FloatingPoint32BitL



15138	16	Analog Stats Channel 13 SD	FloatingPoint32BitL
15140	18	Analog Stats Channel 13 Gust or Gust Dir	FloatingPoint32BitL
15142	20	Analog Stats Channel 14 Average	FloatingPoint32BitL
15144	22	Analog Stats Channel 14 Min	FloatingPoint32BitL
15146	24	Analog Stats Channel 14 Max	FloatingPoint32BitL
15148	26	Analog Stats Channel 14 SD	FloatingPoint32BitL
15150	28	Analog Stats Channel 14 Gust or Gust Dir	FloatingPoint32BitL
15460	0	Serial Stats Channel 101 Average	FloatingPoint32BitL
15462	2	Serial Stats Channel 101 Min	FloatingPoint32BitL
15464	4	Serial Stats Channel 101 Max	FloatingPoint32BitL
15466	6	Serial Stats Channel 101 SD	FloatingPoint32BitL
15468	8	Serial Stats Channel 101 Gust or Gust Dir	FloatingPoint32BitL
15470	10	Serial Stats Channel 102 Average	FloatingPoint32BitL
15472	12	Serial Stats Channel 102 Min	FloatingPoint32BitL
15474	14	Serial Stats Channel 102 Max	FloatingPoint32BitL
15476	16	Serial Stats Channel 102 SD	FloatingPoint32BitL
15478	18	Serial Stats Channel 102 Gust or Gust Dir	FloatingPoint32BitL
15480	20	Serial Stats Channel 103 Average	FloatingPoint32BitL
15482	22	Serial Stats Channel 103 Min	FloatingPoint32BitL
15484	24	Serial Stats Channel 103 Max	FloatingPoint32BitL
15486	26	Serial Stats Channel 103 SD	FloatingPoint32BitL
15488	28	Serial Stats Channel 103 Gust or Gust Dir	FloatingPoint32BitL
15490	30	Serial Stats Channel 104 Average	FloatingPoint32BitL
15492	32	Serial Stats Channel 104 Min	FloatingPoint32BitL
15494	34	Serial Stats Channel 104 Max	FloatingPoint32BitL
15496	36	Serial Stats Channel 104 SD	FloatingPoint32BitL
15498	38	Serial Stats Channel 104 Gust or Gust Dir	FloatingPoint32BitL
15500	40	Serial Stats Channel 105 Average	FloatingPoint32BitL
15502	42	Serial Stats Channel 105 Min	FloatingPoint32BitL
15504	44	Serial Stats Channel 105 Max	FloatingPoint32BitL
15506	46	Serial Stats Channel 105 SD	FloatingPoint32BitL
15508	48	Serial Stats Channel 105 Gust or Gust Dir	FloatingPoint32BitL
15510	50	Serial Stats Channel 106 Average	FloatingPoint32BitL
15512	52	Serial Stats Channel 106 Min	FloatingPoint32BitL
15514	54	Serial Stats Channel 106 Max	FloatingPoint32BitL
15516	56	Serial Stats Channel 106 SD	FloatingPoint32BitL
15518	58	Serial Stats Channel 106 Gust or Gust Dir	FloatingPoint32BitL
15520	60	Serial Stats Channel 107 Average	FloatingPoint32BitL
15522	62	Serial Stats Channel 107 Min	FloatingPoint32BitL
15524	64	Serial Stats Channel 107 Max	FloatingPoint32BitL
15526	66	Serial Stats Channel 107 SD	FloatingPoint32BitL
15528	68	Serial Stats Channel 107 Gust or Gust Dir	FloatingPoint32BitL
15530	70	Serial Stats Channel 108 Average	FloatingPoint32BitL
15532	72	Serial Stats Channel 108 Min	FloatingPoint32BitL
15534	74	Serial Stats Channel 108 Max	FloatingPoint32BitL



15536	76	Serial Stats Channel 108 SD	FloatingPoint32BitL
15538	78	Serial Stats Channel 108 Gust or Gust Dir	FloatingPoint32BitL
15540	80	Serial Stats Channel 109 Average	FloatingPoint32BitL
15542	82	Serial Stats Channel 109 Min	FloatingPoint32BitL
15544	84	Serial Stats Channel 109 Max	FloatingPoint32BitL
15546	86	Serial Stats Channel 109 SD	FloatingPoint32BitL
15548	88	Serial Stats Channel 109 Gust or Gust Dir	FloatingPoint32BitL
15550	90	Serial Stats Channel 110 Average	FloatingPoint32BitL
15552	92	Serial Stats Channel 110 Min	FloatingPoint32BitL
15554	94	Serial Stats Channel 110 Max	FloatingPoint32BitL
15556	96	Serial Stats Channel 110 SD	FloatingPoint32BitL
15558	98	Serial Stats Channel 110 Gust or Gust Dir	FloatingPoint32BitL
15560	100	Serial Stats Channel 111 Average	FloatingPoint32BitL
15562	102	Serial Stats Channel 111 Min	FloatingPoint32BitL
15564	104	Serial Stats Channel 111 Max	FloatingPoint32BitL
15566	106	Serial Stats Channel 111 SD	FloatingPoint32BitL
15568	108	Serial Stats Channel 111 Gust or Gust Dir	FloatingPoint32BitL
15570	110	Serial Stats Channel 112 Average	FloatingPoint32BitL
15572	112	Serial Stats Channel 112 Min	FloatingPoint32BitL
15574	114	Serial Stats Channel 112 Max	FloatingPoint32BitL
15576	116	Serial Stats Channel 112 SD	FloatingPoint32BitL
15578	118	Serial Stats Channel 112 Gust or Gust Dir	FloatingPoint32BitL
15580	0	Serial Stats Channel 113 Average	FloatingPoint32BitL
15582	2	Serial Stats Channel 113 Min	FloatingPoint32BitL
15584	4	Serial Stats Channel 113 Max	FloatingPoint32BitL
15586	6	Serial Stats Channel 113 SD	FloatingPoint32BitL
15588	8	Serial Stats Channel 113 Gust or Gust Dir	FloatingPoint32BitL
15590	10	Serial Stats Channel 114 Average	FloatingPoint32BitL
15592	12	Serial Stats Channel 114 Min	FloatingPoint32BitL
15594	14	Serial Stats Channel 114 Max	FloatingPoint32BitL
15596	16	Serial Stats Channel 114 SD	FloatingPoint32BitL
15598	18	Serial Stats Channel 114 Gust or Gust Dir	FloatingPoint32BitL
15600	20	Serial Stats Channel 115 Average	FloatingPoint32BitL
15602	22	Serial Stats Channel 115 Min	FloatingPoint32BitL
15604	24	Serial Stats Channel 115 Max	FloatingPoint32BitL
15606	26	Serial Stats Channel 115 SD	FloatingPoint32BitL
15608	28	Serial Stats Channel 115 Gust or Gust Dir	FloatingPoint32BitL
15610	30	Serial Stats Channel 116 Average	FloatingPoint32BitL
15612	32	Serial Stats Channel 116 Min	FloatingPoint32BitL
15614	34	Serial Stats Channel 116 Max	FloatingPoint32BitL
15616	36	Serial Stats Channel 116 SD	FloatingPoint32BitL
15618	38	Serial Stats Channel 116 Gust or Gust Dir	FloatingPoint32BitL
15620	40	Serial Stats Channel 117 Average	FloatingPoint32BitL
15622	42	Serial Stats Channel 117 Min	FloatingPoint32BitL
15624	44	Serial Stats Channel 117 Max	FloatingPoint32BitL



15626	46	Serial Stats Channel 117 SD	FloatingPoint32BitL
15628	48	Serial Stats Channel 117 Gust or Gust Dir	FloatingPoint32BitL
15630	50	Serial Stats Channel 118 Average	FloatingPoint32BitL
15632	52	Serial Stats Channel 118 Min	FloatingPoint32BitL
15634	54	Serial Stats Channel 118 Max	FloatingPoint32BitL
15636	56	Serial Stats Channel 118 SD	FloatingPoint32BitL
15638	58	Serial Stats Channel 118 Gust or Gust Dir	FloatingPoint32BitL
15640	60	Serial Stats Channel 119 Average	FloatingPoint32BitL
15642	62	Serial Stats Channel 119 Min	FloatingPoint32BitL
15644	64	Serial Stats Channel 119 Max	FloatingPoint32BitL
15646	66	Serial Stats Channel 119 SD	FloatingPoint32BitL
15648	68	Serial Stats Channel 119 Gust or Gust Dir	FloatingPoint32BitL
15650	70	Serial Stats Channel 120 Average	FloatingPoint32BitL
15652	72	Serial Stats Channel 120 Min	FloatingPoint32BitL
15654	74	Serial Stats Channel 120 Max	FloatingPoint32BitL
15656	76	Serial Stats Channel 120 SD	FloatingPoint32BitL
15658	78	Serial Stats Channel 120 Gust or Gust Dir	FloatingPoint32BitL
15660	80	Serial Stats Channel 121 Average	FloatingPoint32BitL
15662	82	Serial Stats Channel 121 Min	FloatingPoint32BitL
15664	84	Serial Stats Channel 121 Max	FloatingPoint32BitL
15666	86	Serial Stats Channel 121 SD	FloatingPoint32BitL
15668	88	Serial Stats Channel 121 Gust or Gust Dir	FloatingPoint32BitL
15670	90	Serial Stats Channel 122 Average	FloatingPoint32BitL
15672	92	Serial Stats Channel 122 Min	FloatingPoint32BitL
15674	94	Serial Stats Channel 122 Max	FloatingPoint32BitL
15676	96	Serial Stats Channel 122 SD	FloatingPoint32BitL
15678	98	Serial Stats Channel 122 Gust or Gust Dir	FloatingPoint32BitL
15680	100	Serial Stats Channel 123 Average	FloatingPoint32BitL
15682	102	Serial Stats Channel 123 Min	FloatingPoint32BitL
15684	104	Serial Stats Channel 123 Max	FloatingPoint32BitL
15686	106	Serial Stats Channel 123 SD	FloatingPoint32BitL
15688	108	Serial Stats Channel 123 Gust or Gust Dir	FloatingPoint32BitL
15690	110	Serial Stats Channel 124 Average	FloatingPoint32BitL
15692	112	Serial Stats Channel 124 Min	FloatingPoint32BitL
15694	114	Serial Stats Channel 124 Max	FloatingPoint32BitL
15696	116	Serial Stats Channel 124 SD	FloatingPoint32BitL
15698	118	Serial Stats Channel 124 Gust or Gust Dir	FloatingPoint32BitL
15844	0	Calculated Stats Channel 301 Average	FloatingPoint32BitL
15846	2	Calculated Stats Channel 301 Min	FloatingPoint32BitL
15848	4	Calculated Stats Channel 301 Max	FloatingPoint32BitL
15850	6	Calculated Stats Channel 301 SD	FloatingPoint32BitL
15852	8	Calculated Stats Channel 302 Average	FloatingPoint32BitL
15854	10	Calculated Stats Channel 302 Min	FloatingPoint32BitL
15856	12	Calculated Stats Channel 302 Max	FloatingPoint32BitL
15858	14	Calculated Stats Channel 302 SD	FloatingPoint32BitL



15860	16	Calculated Stats Channel 303 Average	FloatingPoint32BitL
15862	18	Calculated Stats Channel 303 Min	FloatingPoint32BitL
15864	20	Calculated Stats Channel 303 Max	FloatingPoint32BitL
15866	22	Calculated Stats Channel 303 SD	FloatingPoint32BitL
15868	24	Calculated Stats Channel 304 Average	FloatingPoint32BitL
15870	26	Calculated Stats Channel 304 Min	FloatingPoint32BitL
15872	28	Calculated Stats Channel 304 Max	FloatingPoint32BitL
15874	30	Calculated Stats Channel 304 SD	FloatingPoint32BitL
15876	32	Calculated Stats Channel 305 Average	FloatingPoint32BitL
15878	34	Calculated Stats Channel 305 Min	FloatingPoint32BitL
15880	36	Calculated Stats Channel 305 Max	FloatingPoint32BitL
15882	38	Calculated Stats Channel 305 SD	FloatingPoint32BitL
15884	40	Calculated Stats Channel 306 Average	FloatingPoint32BitL
15886	42	Calculated Stats Channel 306 Min	FloatingPoint32BitL
15888	44	Calculated Stats Channel 306 Max	FloatingPoint32BitL
15890	46	Calculated Stats Channel 306 SD	FloatingPoint32BitL
15892	48	Calculated Stats Channel 307 Average	FloatingPoint32BitL
15894	50	Calculated Stats Channel 307 Min	FloatingPoint32BitL
15896	52	Calculated Stats Channel 307 Max	FloatingPoint32BitL
15898	54	Calculated Stats Channel 307 SD	FloatingPoint32BitL
15900	56	Calculated Stats Channel 308 Average	FloatingPoint32BitL
15902	58	Calculated Stats Channel 308 Min	FloatingPoint32BitL
15904	60	Calculated Stats Channel 308 Max	FloatingPoint32BitL
15906	62	Calculated Stats Channel 308 SD	FloatingPoint32BitL
15908	64	Calculated Stats Channel 309 Average	FloatingPoint32BitL
15910	66	Calculated Stats Channel 309 Min	FloatingPoint32BitL
15912	68	Calculated Stats Channel 309 Max	FloatingPoint32BitL
15914	70	Calculated Stats Channel 309 SD	FloatingPoint32BitL
15916	72	Calculated Stats Channel 310 Average	FloatingPoint32BitL
15918	74	Calculated Stats Channel 310 Min	FloatingPoint32BitL
15920	76	Calculated Stats Channel 310 Max	FloatingPoint32BitL
15922	78	Calculated Stats Channel 310 SD	FloatingPoint32BitL
16020	0	MCU Diag VIn Raw Power Average	FloatingPoint32BitL
16022	2	MCU Diag VIn Raw Power Min	FloatingPoint32BitL
16024	4	MCU Diag VIn Raw Power Max	FloatingPoint32BitL
16026	6	MCU Diag VIn Raw Power SD	FloatingPoint32BitL
16028	8	MCU Diag VSense 12.4V Average	FloatingPoint32BitL
16030	10	MCU Diag VSense 12.4V Min	FloatingPoint32BitL
16032	12	MCU Diag VSense 12.4V Max	FloatingPoint32BitL
16034	14	MCU Diag VSense 12.4V SD	FloatingPoint32BitL
16036	16	MCU Diag ISense 12.4V Average	FloatingPoint32BitL
16038	18	MCU Diag ISense 12.4V Min	FloatingPoint32BitL
16040	20	MCU Diag ISense 12.4V Max	FloatingPoint32BitL
16042	22	MCU Diag ISense 12.4V SD	FloatingPoint32BitL
16044	24	MCU Diag VSense 3.3V Average	FloatingPoint32BitL



16046	26	MCU Diag VSense 3.3V Min	FloatingPoint32BitL
16048	28	MCU Diag VSense 3.3V Max	FloatingPoint32BitL
16050	30	MCU Diag VSense 3.3V SD	FloatingPoint32BitL
16052	32	MCU Diag ISense 3.3V Average	FloatingPoint32BitL
16054	34	MCU Diag ISense 3.3V Min	FloatingPoint32BitL
16056	36	MCU Diag ISense 3.3V Max	FloatingPoint32BitL
16058	38	MCU Diag ISense 3.3V SD	FloatingPoint32BitL
16060	40	MCU Diag VSense COM-A EXC Average	FloatingPoint32BitL
16062	42	MCU Diag VSense COM-A EXC Min	FloatingPoint32BitL
16064	44	MCU Diag VSense COM-A EXC Max	FloatingPoint32BitL
16066	46	MCU Diag VSense COM-A EXC SD	FloatingPoint32BitL
16068	48	MCU Diag ISense COM-A EXC Average	FloatingPoint32BitL
16070	50	MCU Diag ISense COM-A EXC Min	FloatingPoint32BitL
16072	52	MCU Diag ISense COM-A EXC Max	FloatingPoint32BitL
16074	54	MCU Diag ISense COM-A EXC SD	FloatingPoint32BitL
16076	56	MCU Diag VSense COM-B EXC Average	FloatingPoint32BitL
16078	58	MCU Diag VSense COM-B EXC Min	FloatingPoint32BitL
16080	60	MCU Diag VSense COM-B EXC Max	FloatingPoint32BitL
16082	62	MCU Diag VSense COM-B EXC SD	FloatingPoint32BitL
16084	64	MCU Diag ISense COM-B EXC Average	FloatingPoint32BitL
16086	66	MCU Diag ISense COM-B EXC Min	FloatingPoint32BitL
16088	68	MCU Diag ISense COM-B EXC Max	FloatingPoint32BitL
16090	70	MCU Diag ISense COM-B EXC SD	FloatingPoint32BitL
16196	0	Analog Diag +VIn Raw Power Average	FloatingPoint32BitL
16198	2	Analog Diag +VIn Raw Power Min	FloatingPoint32BitL
16200	4	Analog Diag +VIn Raw Power Max	FloatingPoint32BitL
16202	6	Analog Diag +VIn Raw Power SD	FloatingPoint32BitL
16204	8	Analog Diag VSense 13.3V Average	FloatingPoint32BitL
16206	10	Analog Diag VSense 13.3V Min	FloatingPoint32BitL
16208	12	Analog Diag VSense 13.3V Max	FloatingPoint32BitL
16210	14	Analog Diag VSense 13.3V SD	FloatingPoint32BitL
16212	16	Analog Diag VSense 15V Average	FloatingPoint32BitL
16214	18	Analog Diag VSense 15V Min	FloatingPoint32BitL
16216	20	Analog Diag VSense 15V Max	FloatingPoint32BitL
16218	22	Analog Diag VSense 15V SD	FloatingPoint32BitL
16220	24	Analog Diag VSense 12V Average	FloatingPoint32BitL
16222	26	Analog Diag VSense 12V Min	FloatingPoint32BitL
16224	28	Analog Diag VSense 12V Max	FloatingPoint32BitL
16226	30	Analog Diag VSense 12V SD	FloatingPoint32BitL
16228	32	Analog Diag VSense 5V Average	FloatingPoint32BitL
16230	34	Analog Diag VSense 5V Min	FloatingPoint32BitL
16232	36	Analog Diag VSense 5V Max	FloatingPoint32BitL
16234	38	Analog Diag VSense 5V SD	FloatingPoint32BitL
16236	40	Analog Diag -VIn Raw Power Average	FloatingPoint32BitL
16238	42	Analog Diag -VIn Raw Power Min	FloatingPoint32BitL



16240	44	Analog Diag -VIn Raw Power Max	FloatingPoint32BitL
16242	46	Analog Diag -VIn Raw Power SD	FloatingPoint32BitL
16244	48	Analog Diag VSense-15V Average	FloatingPoint32BitL
16246	50	Analog Diag VSense-15V Min	FloatingPoint32BitL
16248	52	Analog Diag VSense-15V Max	FloatingPoint32BitL
16250	54	Analog Diag VSense-15V SD	FloatingPoint32BitL
16252	56	Analog Diag ISense 12V Average	FloatingPoint32BitL
16254	58	Analog Diag ISense 12V Min	FloatingPoint32BitL
16256	60	Analog Diag ISense 12V Max	FloatingPoint32BitL
16258	62	Analog Diag ISense 12V SD	FloatingPoint32BitL
16356	0	Counter Stats Channel 401 Average	FloatingPoint32BitL
16358	2	Counter Stats Channel 401 Min	FloatingPoint32BitL
16360	4	Counter Stats Channel 401 Max	FloatingPoint32BitL
16362	6	Counter Stats Channel 401 SD	FloatingPoint32BitL
16364	8	Counter Stats Channel 401 Gust or Total	FloatingPoint32BitL
16366	10	Counter Stats Channel 402 Average	FloatingPoint32BitL
16368	12	Counter Stats Channel 402 Min	FloatingPoint32BitL
16370	14	Counter Stats Channel 402 Max	FloatingPoint32BitL
16372	16	Counter Stats Channel 402 SD	FloatingPoint32BitL
16374	18	Counter Stats Channel 402 Gust or Total	FloatingPoint32BitL
16376	20	Counter Stats Channel 403 Average	FloatingPoint32BitL
16378	22	Counter Stats Channel 403 Min	FloatingPoint32BitL
16380	24	Counter Stats Channel 403 Max	FloatingPoint32BitL
16382	26	Counter Stats Channel 403 SD	FloatingPoint32BitL
16384	28	Counter Stats Channel 403 Gust or Total	FloatingPoint32BitL
16386	30	Counter Stats Channel 404 Average	FloatingPoint32BitL
16388	32	Counter Stats Channel 404 Min	FloatingPoint32BitL
16390	34	Counter Stats Channel 404 Max	FloatingPoint32BitL
16392	36	Counter Stats Channel 404 SD	FloatingPoint32BitL
16394	38	Counter Stats Channel 404 Gust or Total	FloatingPoint32BitL
16396	40	Counter Stats Channel 405 Average	FloatingPoint32BitL
16398	42	Counter Stats Channel 405 Min	FloatingPoint32BitL
16400	44	Counter Stats Channel 405 Max	FloatingPoint32BitL
16402	46	Counter Stats Channel 405 SD	FloatingPoint32BitL
16404	48	Counter Stats Channel 405 Gust or Total	FloatingPoint32BitL



APPENDIX C | DECLARATIONS OF CONFORMITY

To view current Declarations of Conformity including CE, China RoHS, and others, visit the following page: [NRG LOGR | Solar Declarations of Conformity](#)



APPENDIX D | WARRANTY

NRG Systems (NRG) warrants its products for a period of two years from date of original purchase solely for the benefit of the original consumer purchaser. If this product is determined to be defective in materials or workmanship, NRG will, at NRG's option, repair or replace this product without charge. This warranty does not cover damage due to improper installation or use, accident or misuse, damages due to any unauthorized service or lightning. This warranty also will not apply if any seal on any instrument or sensor is broken, if any internal components have been manipulated, if any cable has been severed, or the equipment was not adequately grounded.

To return a defective product, request an SR (Service Request) number by calling us at the number below or by emailing support@nrgsystems.com, or by submitting a request through our website's Technical Services area.

Please provide the serial number of the item as well as date of purchase. No products will be accepted for warranty work without an SR number. The product must be returned, postage prepaid, to NRG with a brief description of the problem, SR number and a return address with phone number.

The foregoing limited warranty is given in lieu of all other warranties, express or implied. NRG specifically disclaims all implied warranties including, but not limited to, any implied warranties of merchantability and fitness for a particular purpose.

The above limited warranty expressly excludes, and NRG shall not be liable for, any incidental or consequential damages caused by or related to the selection, use of, inability to use or malfunction of this product.

NRG will make a good faith effort to repair or replace promptly any product which proves to be defective within the warranty period. First, contact NRG or the representative from whom the product was purchased and ask for an SR number. Inspect your shipments for damage to packages or missing packages immediately upon receipt. Record any such exceptions on the freight receipt of the delivery agent. If any contents are damaged or missing, report this in writing to the freight carrier and send NRG a copy of the damage report. If you insured the shipment yourself, report any damages to your insurance carrier.



Sending Items for Repair

International Customers

Contact NRG Systems by phone, email, or through our website to obtain an SR number (Service Request). Write the SR number clearly on all shipping cartons.

Tel: 802-482-2255 Fax: 802-482-2272

Email: support@nrgsystems.com Website: <https://www.nrgsystems.com/support/customer-support/>

Before sending the repair item to NRG Systems, check with your local customs authorities about provisions in your country for exporting and re-importing repair items. Some countries treat repair shipments like new shipments and charge import duties and taxes again upon re-importation. Other countries have specific steps to follow or specific forms to complete which help reduce the import duties upon re-import of the item.

Send your item to NRG Systems "Delivery Duty Paid" (see address below) using a door-to-door courier service such as UPS, FedEx, or DHL. If the repair is not urgent, please send your package by Airmail. (Courier services deliver the package directly to us, customs cleared.)

NRG Systems will not accept packages shipped Freight Collect or with Collect charges.

If NRG Systems refuses the shipment, the courier service will charge your account return freight charges.

DO NOT send return items by direct or consolidated air freight service with an airline.

The cost for air freight may seem lower than the courier service, but air freight costs do not include customs clearance, airport handling, break bulk fees, and inland delivery to NRG Systems.

Attach a Commercial Invoice to the carton. The Commercial Invoice should include the following information:

Name and address of the shipper.

NRG Systems' complete address and telephone number as the consignee.

Description of the items being returned.

Quantity of each item being returned.

Value for customs / insurance (purchase price or replacement cost).

Number of cartons with respective weights and dimensions.

Example of ship to address:

NRG Systems
Attn: SR# _____
110 Riggs Road
Hinesburg, VT 05461 USA
1-802-482-2255

Please include the following statement to avoid paying US import duties:

"These items are being returned to their U.S. manufacturer. Country of manufacture and origin is USA, HTS CODE 9801.00.1012."



Pack your repair item in a sturdy packing carton. Tag each item with a brief description of the problem.

Insure your shipment against damage or loss in transit. Be sure to check the appropriate box and enter a "Value for Carriage" (insurance) on your air waybill. The value is the purchase price of the equipment or what it would cost to replace the equipment if the shipment were lost. Keep a record of the tracking number.

Once your item arrives, we will assess the item and notify you of the repair cost. Any repair charges and freight costs, if applicable, are payable before NRG Systems will return the repaired item to you via door-to-door courier service. NRG Systems will send you a shipment advisement when the repaired item is shipped.

US Customers

Please see items 1, 4, and 5 above. Send your item(s) to NRG Systems "Freight Prepaid and Insured."
Shipments sent freight collect will not be accepted by NRG Systems.

APPENDIX E | REFERENCES

Daniel, R. Deceglie, M. G., Micheli, L., Muller, M. (2017). Time Series Analysis of Photovoltaic Soiling Station Data: Version 1.0. Report released by *National Renewable Energy Laboratory and Colorado School of Mines*. Golden, CO. Retrieved from <https://www.nrel.gov/docs/fy17osti/69131.pdf>