

# ZX300 POWER TRAILER, MODERATE CLIMATE INSTRUCTIONS



**NRG**Systems®

[support@nrgsystems.com](mailto:support@nrgsystems.com)

+1 802 482 2255



## NRG INSTRUCTIONS

---

# ZX300 Power Trailer | Moderate Climate

Authors:  
Technical Services

ZX300\_PowerTrailer\_ModerateClimate  
Rev. 1.0



## TABLE OF CONTENTS

<b>INTRODUCTION</b> .....	<b>4</b>
Warning & Notices .....	4
Trailer Specifications .....	4
<b>MATERIALS &amp; TOOLS</b> .....	<b>5</b>
Required Tools (Included) .....	5
Additional Tools (Not Included) .....	5
Recommended Documentation .....	5
<b>POWER TRAILER</b> .....	<b>6</b>
Towing & Siting .....	6
<i>Vehicle Requirements</i> .....	6
<i>Parking the Trailer</i> .....	6
<i>Transport</i> .....	7
Trailer Assembly .....	8
<i>Considerations</i> .....	8
<i>Mounting the Frame &amp; PV Panels</i> .....	8
<i>ZX300 Lidar-Related Connections</i> .....	12
Modem Configuration .....	14
Anchoring .....	15
<b>ZX300 LIDAR</b> .....	<b>16</b>
Lidar Setup .....	16
<i>ZX Met Station Assembly</i> .....	16
Powering the Lidar .....	18
ZX300 Function Check .....	19





## INTRODUCTION

The Moderate Climate PV Trailer is a PV-based, trailer-mounted power supply designed by NRG to provide power to a Lidar at sites with moderate solar resource. Economical, portable, and consistent, this solution simplifies Lidar deployments by providing reliable power at many locations in the continental United States.

Outfitted with over 1KW of PV capacity and 600Ah of battery capacity, the Moderate Climate PV Trailer is designed to keep your Lidar operating autonomously throughout the year without interruption.

Step-by-step instructions for the installation of the Moderate Climate PV Trailer assembly are provided below, including unpacking the equipment, deploying the PV panels and connecting the ZX300 lidar. This trailer assembly includes all the parts and tools required to get the system up and running.

## Warning & Notices

---



*Access to low voltage (24 V DC) is required. Use caution when connecting PV panels and working inside the connection cabinet.*

---

### NOTICE

*The trailer is not equipped with electric brakes.  
Recommended minimum towing capacity: 3000 lbs.*

---



**NEVER** tow the trailer with the frame & PV panels attached to the exterior of the trailer.

**ALWAYS** remove and stow the frame and PV panels prior to connecting a vehicle to and moving the trailer.

*Damage to any equipment that was not stowed properly prior to moving the trailer is not covered under warranty.*

---

## Trailer Specifications

Complete trailer specifications can be found on our website [here](#).



### **MATERIALS & TOOLS**

#### **Required Tools (Included)**

The following tools are included with each trailer:

- Screwdriver | 1/4" Flathead
- Screwdriver | #2 Phillips
- Double open-ended Wrench | 3/8" x 7/16"
- Double open-ended Wrench | 1/2" x 9/16"
- Double open-ended Wrench | 11/16" x 3/4"
- Adjustable Wrench | 8" length
- 2' Stepladder
- PV Connector Tool

#### **Additional Tools (Not Included)**

- Metal bar (For screw-in anchor installation)
- 5/32" Hex key
- Wire terminal crimpers

#### **Recommended Documentation**

- ZX300 Documentation (Located on the USB drive included with ZX300 Lidars)



### POWER TRAILER

#### Towing & Siting



#### Vehicle Requirements

- 2" Ball
- 3000 lb towing capacity minimum
- 4-pin flat connector (lights)

#### Parking the Trailer

- 
- 1 When arriving at the site, be sure to select a relatively level location, and orient the driver's side of the trailer toward South. The ground should be firm, but the included blocking will provide extra stability.

Park the vehicle & trailer at the selected location.

- 
- 2 Place a block under the tongue jack and rotate the jack into position.
  - 3 Open the tongue clip, disconnect the safety chains, and unplug the light harness.
  - 4 Use the jack to raise the tongue off the vehicle's hitch ball. Once clear, move the vehicle forward and clear of the trailer.
  - 5 Place blocks under the rear corner jacks and engage the jacks to stabilize the trailer.
  - 6 Locate the side jacks and extend the driver's side jack until it reaches the last hole. The passenger side jack is not extended. Block both jacks and crank them down until they are holding some of the trailers weight.
  - 7 Adjust the jacks until the trailer is relatively flat. Use a level to verify.
-



### **Transport**

Prior to moving the trailer, verify that all anchor cables have been disconnected and anchors have been removed from the ground.

The PV panel frame can be secured vertically by removing the struts and letting the frame hang on the top pivot point. The frame can then be locked into place by inserting the long locking arm (shown below) into the low part of the frame.



---

*Under no circumstances should the trailer ever be towed or moved any distance without first removing the PV panels from the frame and securely stowing them inside the trailer.*



*NRG Systems accepts no responsibility for damage to the trailer, Lidar, or any other related components caused by towing or moving the trailer any distance for any reason.*

---



### Trailer Assembly

Once parked, the trailer can now be set up to provide power to the Lidar.

#### *Considerations*

- Items have been secured with bungee cords, ratchet straps, cardboard pieces, and blocking. When unpacking, be sure to save all these materials for future transport.
- When using a ZX300 Lidar with the trailer, the original ZX shipping crate may be strapped inside the front of the trailer. Save this in case the ZX needs to be shipped without the trailer.

### *Mounting the Frame & PV Panels*

---

- 1 Unstrap the PV panel frame & remove it from inside the trailer.







- Mount the frame to the side of the trailer by holding it in position against the black mounting bracket and installing the pivot bolts/nuts/washers (1/2"-13 threaded; shown below).

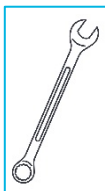
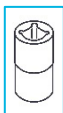

- Swing the angle-positioning struts out from the frame and attach them to the holes in the bottom of the mounting bracket using another pair of 1/2"-13 bolts/nuts/washers.

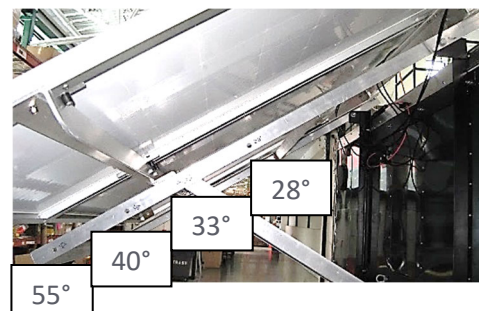
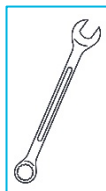
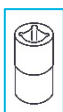

Once mounted to the bracket, the angle can be adjusted between 52°, 40°, 33°, and 28° depending on the season and location.



#### 4 Mount the PV Panels to the frame.

- Remove the ratchet straps securing the panels inside the trailer.
- Remove the shipping bracket from the top of the panels.
- Unload the outermost panel from the trailer.

**NOTICE**

*Use a bungee cord to temporarily secure the remaining panels.*

- Lift the panel onto the frame and into position. Panels are installed vertically, and with the **cables & connectors at the top**.

**NOTICE**

*Use two people to lift and move the panels. They are not small.*

Once on the frame, the panels will rest on the lower crossbar using two pins.



- Line up the holes in the panel & the frame crossbars and install the ¼-20 serrated flange bolts (PN 12024).

Repeat this step for the remaining panels in the trailer.



### 5 Connect the PV panels to the trailer charging system.

- Loosen the strain relief for each pair of cables and pull through enough cable (from inside the trailer to the exterior) to be fed through the loops on the roof trim of the trailer and to each pair of PV panels. The cables may have been fed through these loops during the manufacturing process.

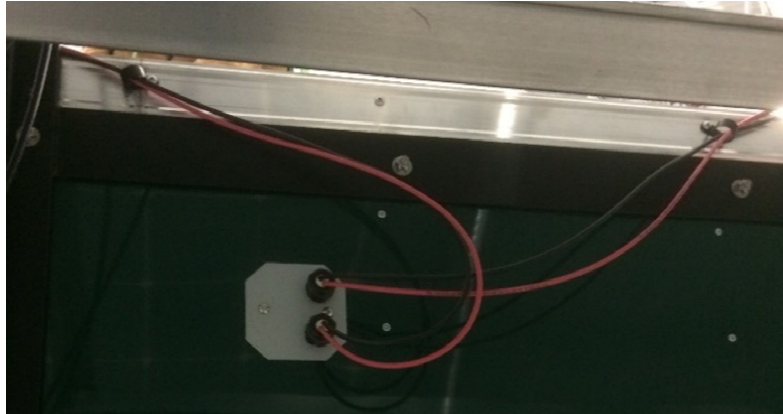
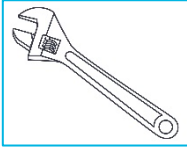

Once satisfied, retighten the cable glands to seal around the cables.

- Find the MC4 parallel branch connectors on the inside wall of the trailer. Bring them out to the exterior of the trailer and connect them to each of the cables that pass through cable glands in the trailer wall.



- Connect the other ends of the parallel branch connectors to the PV panel connectors. **Ensure that cable colors match throughout all connections.**
- Secure cable slack as needed with zip ties.



### ZX300 Lidar-Related Connections

- 1 Antennas for the modem and GPS come pre-installed to a bracket at the front of the trailer exterior.

If a different antenna is needed for any reason, use the existing antennas and cables as guides for the replacement.



#### NOTICE

*When using a modem supplied by NRG and purchased with the trailer, the modem comes pre-installed. If you are supplying your own modem or a modem purchased separately, it must first be installed inside the electrical cabinet and connected to the Ethernet switch inside the cabinet with a short Ethernet Cable.*

- 2 Set up the Lidar-modem 25' Ethernet cable.
  - Attach one end of the Ethernet cable to the Ethernet switch inside the electrical cabinet.

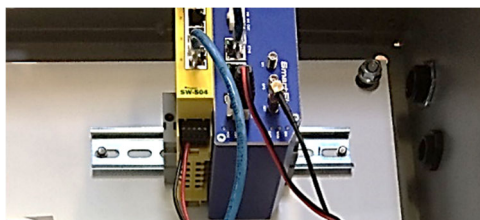

*When the trailer arrives from NRG, the 25' Ethernet cable can be found coiled and attached to the battery lead jacket on top of the electrical cabinet.*

- Feed the other end through one of the unused cable glands next to the electrical cabinet inside the trailer, towards the front. Pull sufficient slack through to allow the Ethernet cable to reach the location that the ZX will be installed.

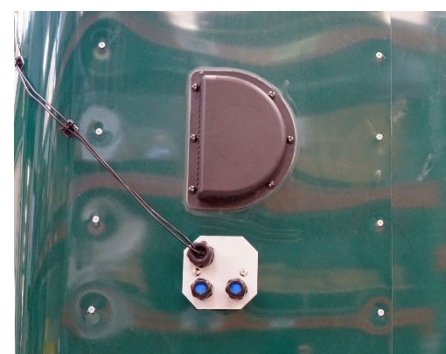





## ZX300 Power Trailer | Moderate Climate

**3** Connect Lidar power cord.

- Run Lidar power cord into the trailer through the cable gland next to the one used for the Ethernet cable, and into electrical cabinet through a second cable gland located on lower half of the side of the electrical cabinet.

Retighten the cable gland caps to seal the gaskets around the power cord jacket.

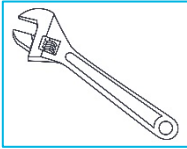

- Connect the red wire to 15-amp breaker and the white lead to the shunt on the DIN rail as shown below.

A ring terminal should be crimped onto the end of the white wire, if it has not been done already.

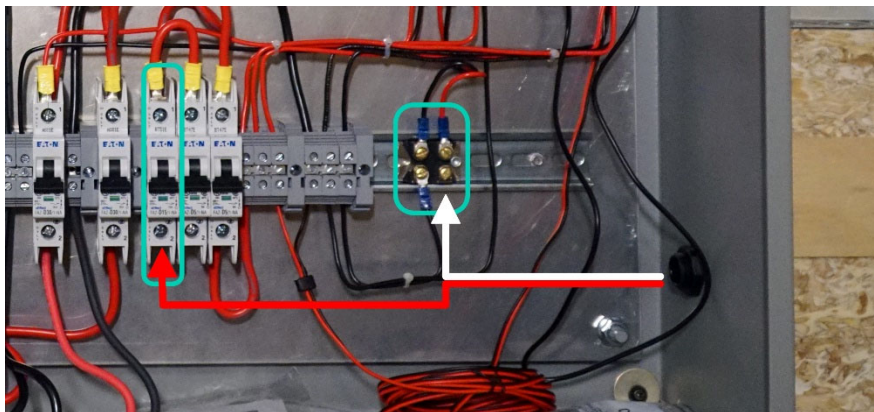
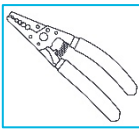





## Modem Configuration

Follow the steps below to configure the modem inside the Power Trailer.

### NOTICE

Contact the cellular service provider for current APN, username, & password values for your account.

### NOTICE

If the modem & SIM card were purchased with the Power Trailer, then they come pre-installed. In that case, these steps may not be necessary.

## Procedure

- 1 Locate the (generally blue) modem inside the electrical cabinet, in the top right corner.

- 2 Install SIM card into the slot.

For modems supplied by NRG, the SIM slot is in the rear of the modem.

- 3 Connect a laptop to the Ethernet switch using the spare 7' Ethernet cable located inside the electrical cabinet or connect via wifi, as follows:  
Network (SSID) | ZXNET  
Password | remotesensor

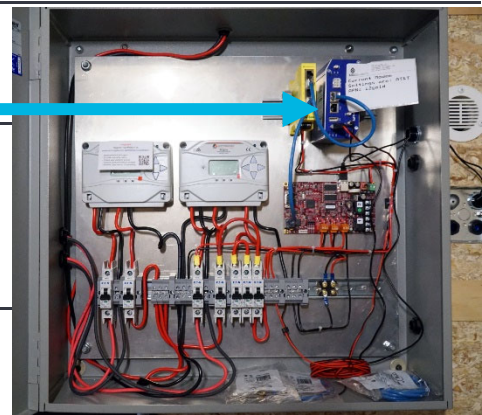

- 4 On the laptop, open a web browser and enter the following IP address to navigate to the modem configuration page (assuming the modem was supplied by NRG):  
192.168.1.100

Enter the login credentials:

Username | root

Password | RNRG

- 5 Once on the configuration page, navigate to:  
Configuration > Mobile WAN

- 6 Enter the APN & username/password (if applicable) supplied by your cellular service provider.  
Scroll down the page and click "Apply" to save the changes.



## Anchoring

The trailer ships with four 4-inch screw-in earth anchors & guy wires that can be used if additional stability is desired. There are two anchor points on each side of the trailer.

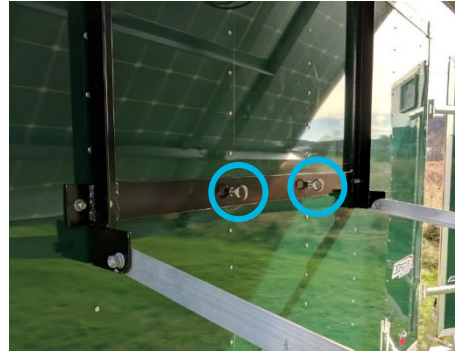
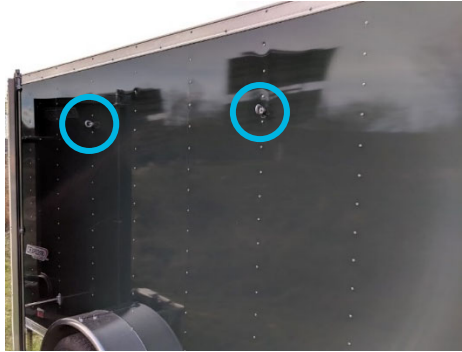

- 1 Attach the swaged end of each anchor cable to an anchor point on the trailer wall using a shackle.



- 2 For each anchor cable:
  - Unscrew the turnbuckles to maximum extension.
  - Lay anchor cables out along the ground at 45° respective to the sides of the trailer.
- 3 Screw the anchors into the ground.
  - Find a suitable location for an anchor along each anchor cable, leaving a minimum distance of 2-3' from the anchor location to the end of the respective anchor cable.
  - Use a long metal bar to screw each anchor into the ground at the desired locations.
- 4 Attach each anchor cable to the respective anchor by looping the cable through the end of the anchor, doubling back, and securing with wire rope clips.

Tighten wire rope clips and ensure that the saddle is on the tensioned part of the cable (between the trailer and anchor).
- 5 Adjust final tension with the turnbuckles until the cables are secure.



## ZX300 LIDAR

### Lidar Setup

The ZX300 Deployment Guide and Configuration Guide should be followed when setting up the ZX300. These guides are available on the USB drive included in the accessory box that comes with the ZX300 or from NRG Technical Support.

**NOTICE**

*The ZX300 should be placed on a firm, stable surface (directly on the ground is OK) at least 6 feet away from the Power Trailer.*

### ZX Met Station Assembly

- 1 Attach the 10 m cable provided with the trailer to the met station sensor.
- 2 Affix the met station sensor to the met station extension provided with the ZX300.
- 3 Mark the Met station extension to correspond to the north mark on the met station sensor.



Attach this assembly to the top of the mast that is attached to the trailer. Orient the north mark to align with the north mark on the lidar, and add a matching mark to the trailer mast.

Secure using the two set screws in the coupling unit on the mast.

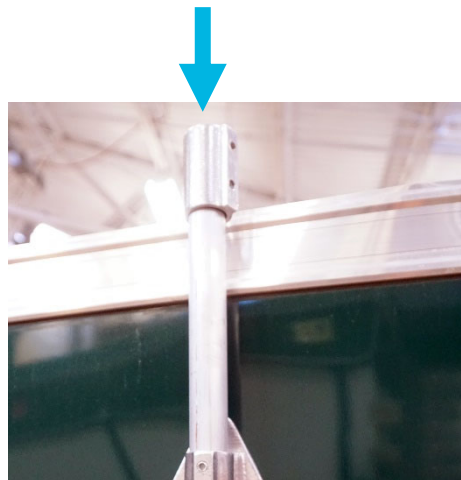



- 
- 4 Loosen the set screws in the two mounts securing the mast to the trailer.

Raise the mast and met station so that the met station is above the top of the solar panels. Verify that the met station north mark is aligned with the lidar north mark.

Tighten the set screws securely.

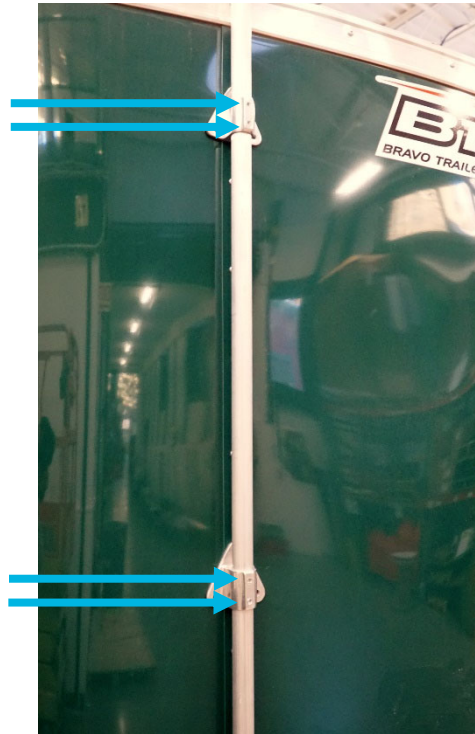
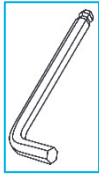

- 
- 5 Attach the end of the cable to the MET port on the ZX300.
-



## Powering the Lidar

Once the Lidar and Power Trailer have been completely set up, the Lidar can now be powered on.

### NOTICE

*The following steps take place inside the Power Trailer electrical cabinet and **must** be done in the order specified.*

Refer to the image below. Breakers are marked with labels and corresponding step numbers.

- 1 Turn on the breakers to the Charge Controller.
- 2 Turn on the breakers to the PV panels.
- 3 Turn on the breaker to the Lidar.
- 4 Turn on the breaker to the modem.

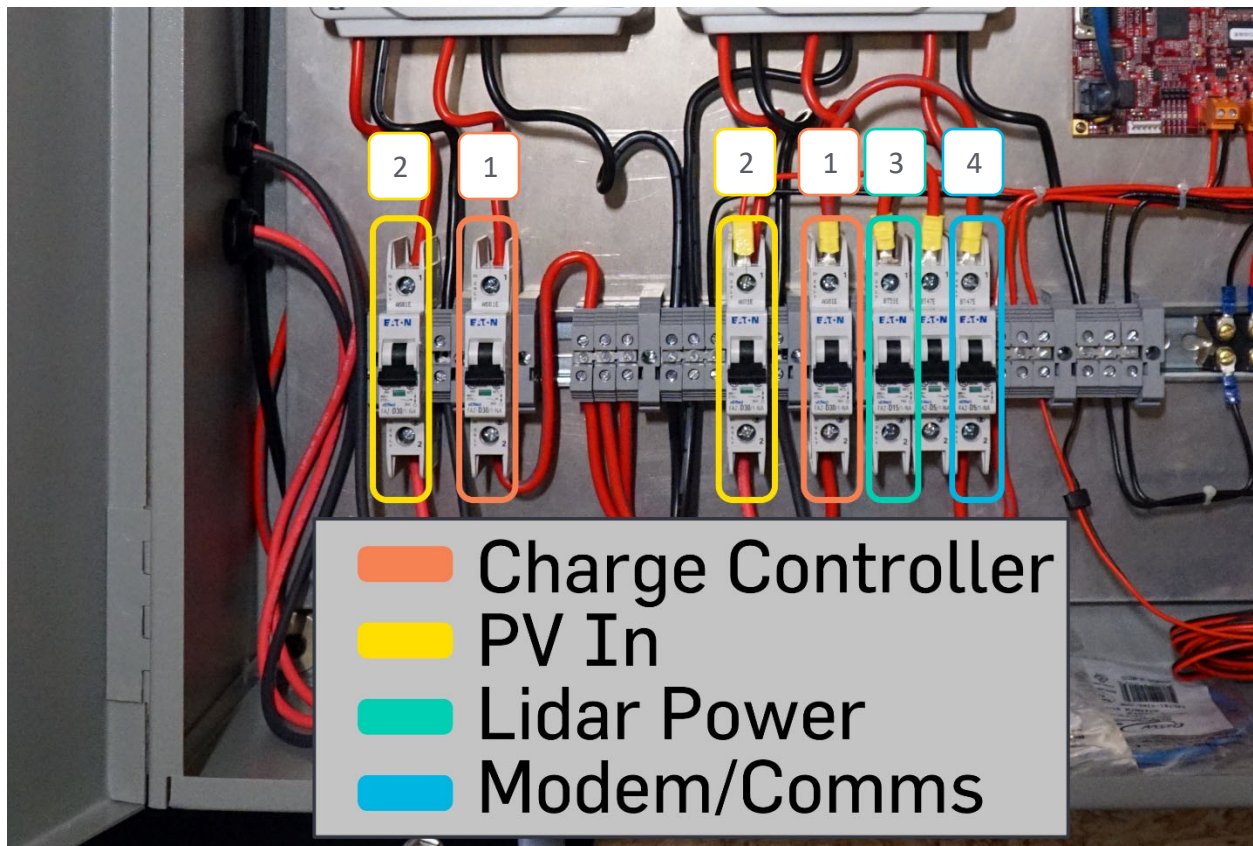





### ZX300 Function Check

Refer to the ZX300 Comms Guide and Configuration Guide for details.

---

- 1** With the ZX300 powered on, use a laptop with Waltz installed to connect to the Lidar with one of the following methods:
    - Through an Ethernet connection to the switch inside the electrical cabinet.
    - Through the modem’s ZXNET wifi network.

---

  - 2** Click the “Live” button in Waltz.

---

  - 3** Enter the local IP address of the ZX300: 192.168.1.10.

---

  - 4** Under “Actions” choose “Send Test Message” to verify the comms functionality.
-