



NRG INSTRUCTIONS

Solar Tower Installation | Pile Mount

Steel Beam Pile Mount for Solar Monitoring

Authors:
Technical Services

SolarTower_PileMount_Instructions
Rev. 3.0



TABLE OF CONTENTS

INTRODUCTION	3
Overview	3
About These Instructions	3
Typographic Conventions	3
Technical Support	3
Safety Considerations	4
MATERIALS & TOOLS	5
Personal Protective Equipment	5
Required Tools	5
SITE PLANNING	6
Pre-Installation Preparation	6
<i>Site Security</i>	<i>6</i>
TOWER ASSEMBLY	6
Solar Tower Tube Heights	6
Steel Pile Installation	6
Procedure	7
APPENDIX A SOLAR TOWER PARTS LIST/BOM	12



INTRODUCTION

Overview

The Solar Tower from NRG Systems is designed for the solar PV professional looking for quick and repeatable deployments as well as reliable autonomous operation. This tower is available in several configurations:

- A temporary, guyed configuration for pre-construction Solar Resource Assessment (SRA) campaigns
- A permanent, pad-mount configuration for post-construction Solar Resource Monitoring (SRM) campaigns.
- A permanent, steel I-beam pile-mount configuration for post-construction Solar Resource Monitoring (SRM) campaigns in locations not suited for concrete pads.

An array of accessories are available to tailor the system to these different applications. Please see our website or contact the NRG Sales Team for more information.

About These Instructions

These instructions deal with the assembly and mounting of the NRG Solar Tower to a steel I-beam pile driven into the ground. This baseplate is designed to be used on a poured concrete pad with anchors pre-installed in the pattern outlined in these instructions. Due to the strength of the pile mounting solution, no guy wires are needed for the tower in this configuration.

Typographic Conventions



Notes throughout the document.

Warnings throughout the document.

Technical Support

NRG Systems offers a variety of support options to help you get the most from your NRG Systems products. If you have questions, first look in the published product documentation. The best places to find information and documents are on the respective product pages of the NRG Systems website.

If you cannot find the answer, contact your Salesperson or NRG Systems Technical Support for assistance using the information below. Customer support is available 8:30 AM to 5:00 PM EST, Monday through Friday.

Telephone: 802-482-2255

Email: support@nrgsystems.com



Safety Considerations



READ ALL INSTRUCTIONS AND WARNINGS BEFORE BEGINNING ANY TOWER INSTALLATION. EVERY INSTALLATION CREW MEMBER SHOULD CAREFULLY READ AND UNDERSTAND ALL WARNINGS, INSTRUCTIONS AND OTHER INFORMATION IN ALL RELATED AND RELEVANT DOCUMENTATION.



DO NOT INSTALL TOWER NEAR ELECTRICAL POWER LINES. METAL TOWER COMPONENTS EFFICIENTLY CONDUCT ELECTRICAL CURRENT AND CAN RESULT IN SERIOUS INJURY OR DEATH IF THEY COME IN CONTACT WITH HIGH VOLTAGE ELECTRICAL LINES. SURVEY THE PROPOSED INSTALLATION SITE AND DO NOT BEGIN ANY TOWER INSTALLATION IF ANY ELECTRICAL LINES ARE PRESENT. MAINTAIN A DISTANCE OF AT LEAST 100 FEET (30 METERS) BETWEEN THE TOWER AND ANY POWER LINES.



DO NOT BEGIN OR CONTINUE TOWER INSTALLATION DURING AN ELECTRICAL STORM. IF LIGHTNING STRIKES A TOWER OR ITS METAL COMPONENTS, SERIOUS INJURY OR DEATH COULD OCCUR TO THOSE WORKING WITH OR AROUND IT. DO NOT BEGIN AN INSTALLATION, OR CONTINUE ONE, DURING AN ELECTRICAL STORM OR IF ONE IS IMMINENT.



MATERIALS & TOOLS

The materials & tools for this manual pertain to the assembly and setup of the tower only. This does not include anything needed to also install a SymphoniePRO Data Logger and commonly-used sensors, booms, & wiring. **For complete parts listing and BOM, see Appendix A | Solar Tower Parts List/BOM.**

Personal Protective Equipment

- Gloves
- Safety Glasses
- Safety toe boots
- Hard hat
- Sunscreen

Required Tools

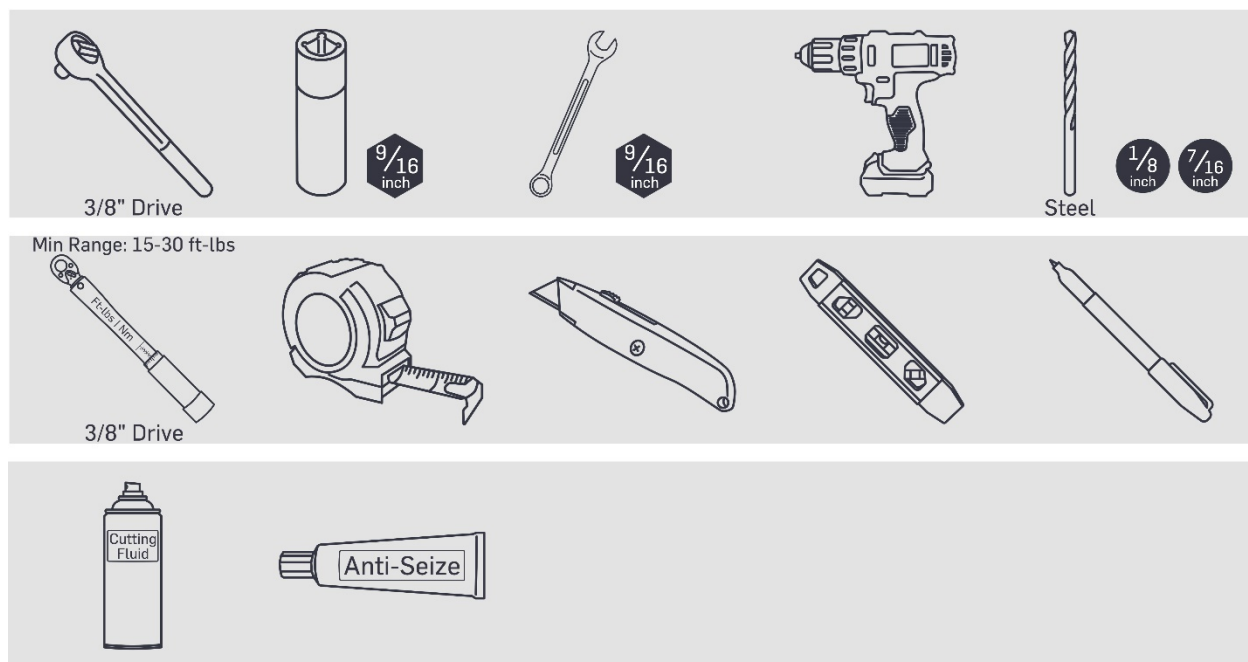



SITE PLANNING

Pre-Installation Preparation

Planning your solar measurement system prior to field deployment is an important part of the installation process and will help move the process along smoothly. Several aspects of the planning process that are highlighted below.

Site Security

Securing your tower and equipment is important. It is up to you to determine the best security measures to employ. Fencing, cameras, and frequent site visits are all recommended ways to help protect the site.

TOWER ASSEMBLY

Solar Tower Tube Heights

The Solar Tower is available in multiple heights. Unless otherwise noted, this procedure applies to all 1-piece NRG Solar Tower models that have 3.5" diameter tube.

Steel Pile Installation

Prior to setting up the Solar Tower, a steel beam pile will need to be driven into the ground. **At least 24" of the pile must remain above the ground.**

Use procedures recommended by the manufacturer or the installation partner. **Do not contact NRG for any information about installing the pile.**



IT IS UP TO YOU TO DETERMINE THE APPROPRIATE SIZE OF THE STEEL PILE TO ADEQUATELY SUPPORT THE SOLAR TOWER. CONTACT YOUR PREFERRED CIVIL ENGINEER FOR GUIDANCE. DO NOT CONTACT NRG SYSTEMS FOR SIZE SPECIFICATIONS. THESE SPECIFICATIONS VARY DEPENDING ON THE LOCATION AND THE SOIL WHERE THE TOWER IS BEING INSTALLED. FAILURE TO INSTALL A PILE CAPABLE OF SUPPORTING YOUR SOLAR TOWER MAY CAUSE THE TOWER TO FALL AND DAMAGE EQUIPMENT. SUCH TYPES OF DAMAGE ARE NOT COVERED BY WARRANTY.



Procedure

- 1 Unpack & sort all components. Verify that they are present and undamaged. Refer to **Appendix A | Solar Tower Parts List/BOM** for a complete parts list.

Note: Some projects may specify that the pile has holes drilled into it by the contractor responsible for driving the pile into the ground. In those cases, begin with Step 4 of the procedure.

NRG Systems still recommends that the tower installer bring all recommended tools with them in case the mounting holes are not drilled in the correct places.

- 2 Mark the location of each hole. Refer to the diagram for the exact layout.
 - Ensure that the holes are in a plumb line along the pile.
 - The lowest pair of holes should be at least 8" above the ground.

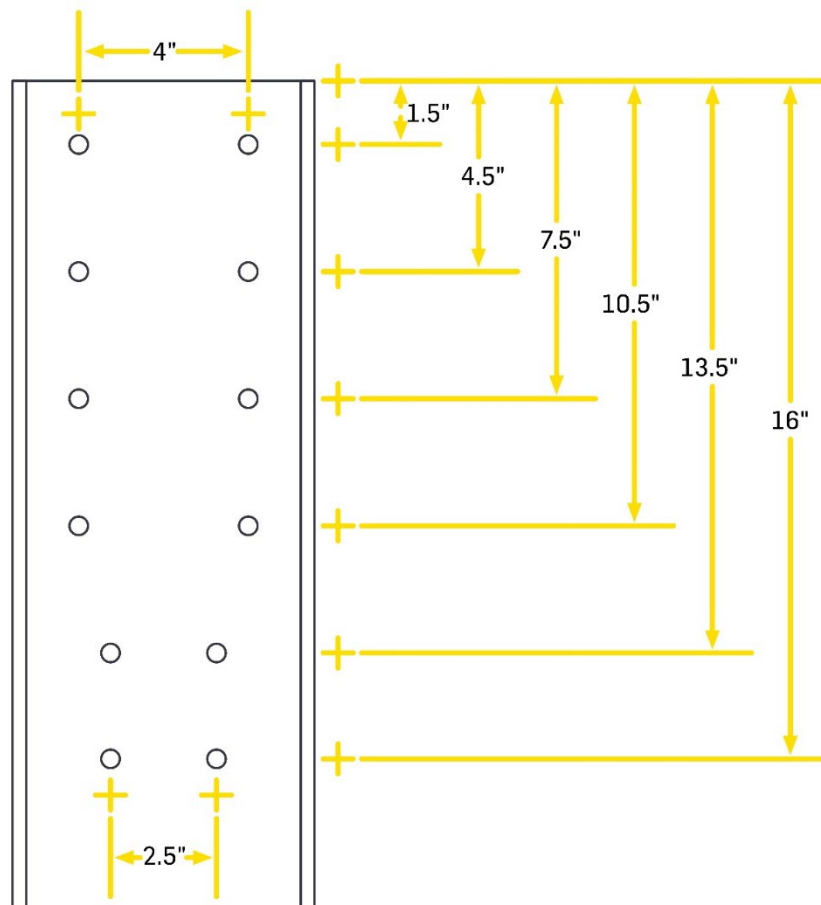
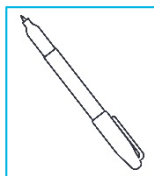
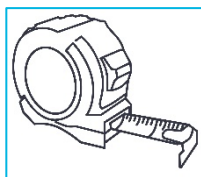



3 Drill out the holes marked in the pile.

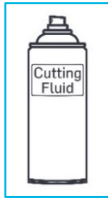

- Apply a generous amount of cutting fluid when drilling each hole to minimize dulling of the drill bits.

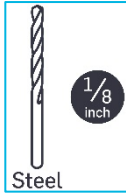

- Use a 1/8" (~3mm) bit for pilot holes.

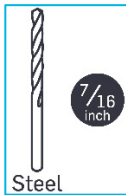

- Use a 7/16" (~11mm) bit for the full-width holes.



- 4 Mount the L-bracket to the pile.
 - Use the supplied 3/8" bolts/nuts/ washers/split-lock washers to attach the bracket through the lower set of four holes. Refer to the exploded diagram below for assembly details.
 - Apply a small amount of anti-seize to the bolt threads.



- Tighten using a 9/16" socket & wrench.

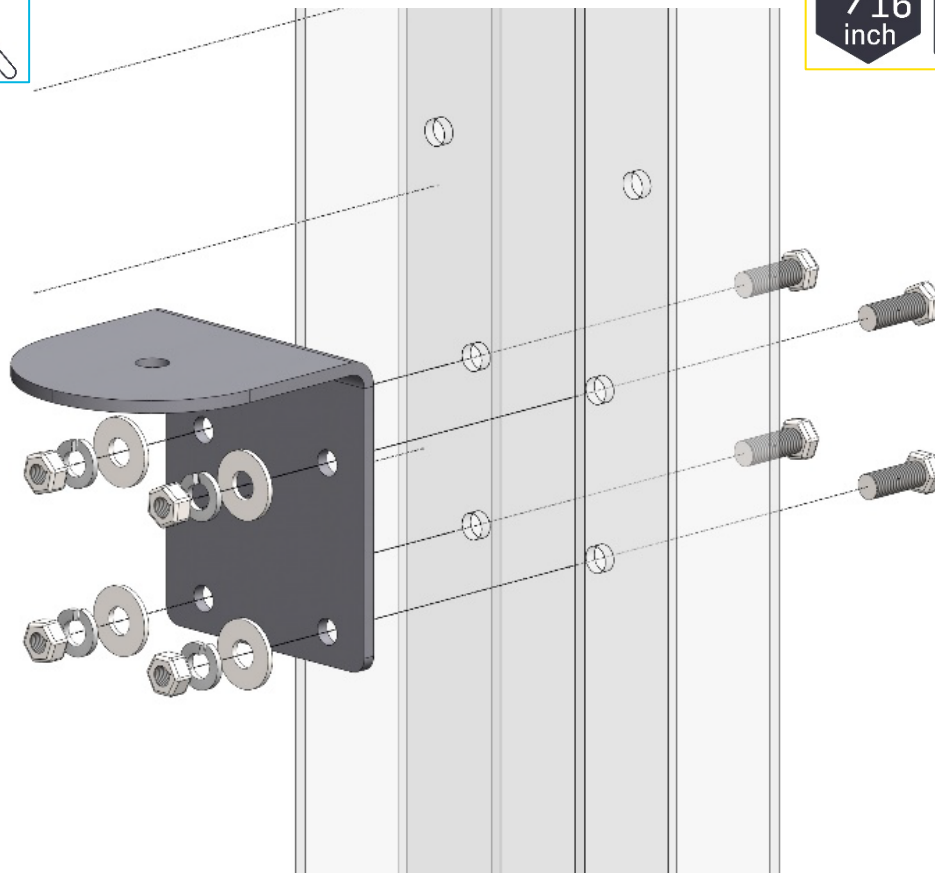
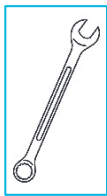
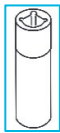

- 5 Torque the L-bracket mounting bolts to 15 ft-lbs (20.3 Nm).

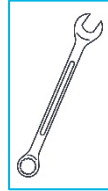
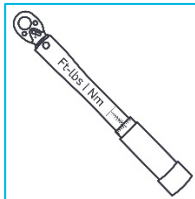



- 6 Loosely attach the U-bolts to the pile through the upper four pairs of holes.
- Apply a small amount of anti-seize to the bolt threads.
 - Hand-thread the nuts onto the end of the U-bolts just enough to engage the last few threads.



- 7 Mount the tower tube to the pile.
- Place the tower tube in the center of the four clamping U-bolts & slide it down to rest on top of the L-bracket.
 - Tighten the nuts with a 9/16" deep socket & ratchet.

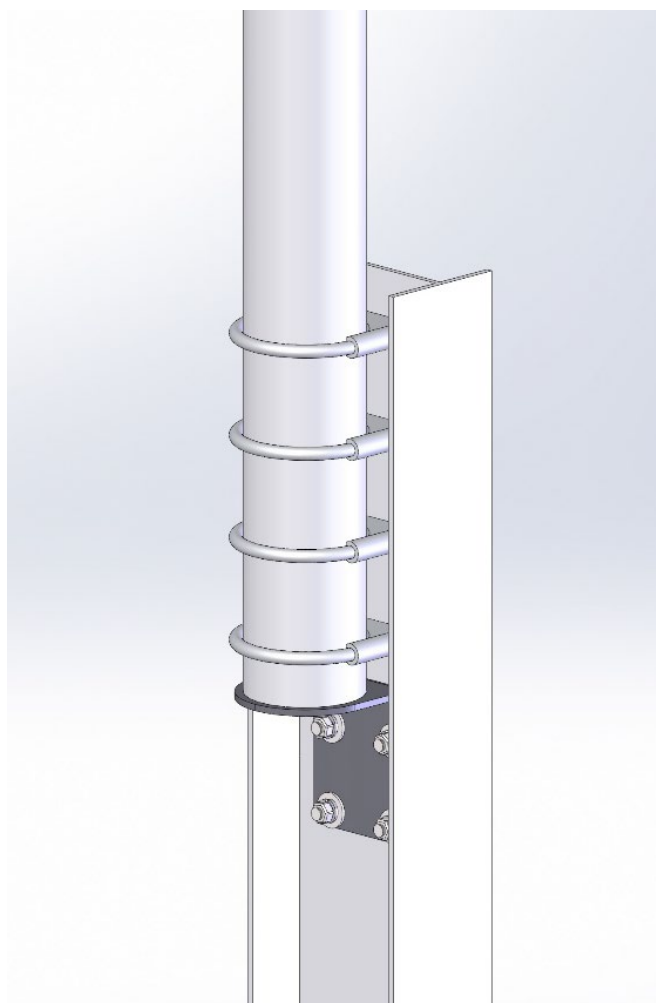
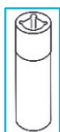

**8 Plumb the tower.**

Place a magnetic angle finder or a torpedo level against the tower tube to check plumb.

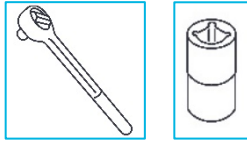
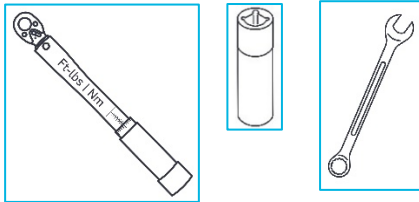

If minor adjustment is needed, then use the clamping U-bolts.

**9 Torque the clamping U-bolts to 29 ft-lbs (39.3 Nm).**

The tower is now erect and ready to accept instruments, booms, sensors, and other accessories. Please refer to each individual instruction sheet or manual for more information about these.

**APPENDIX A | SOLAR TOWER PARTS LIST/BOM**

NRG Part Number	Description	Qty
14232	U-bolt 3.625"	4
1518	Bolt 3/8"-16 threaded 1 inch length Galvanized	4
15042	Lock washer 3/8" Galvanized	4
2814	Flat washer 3/8" Galvanized	4
15041	L-bracket Tower Mount	1
9013	Tower tube 3.5 inch diameter 2.2m length	1*
14948	Tower tube 3.5 inch diameter 3m length	1**

*Kit #15037 contains a 2.2m tower tube.

**Kit #15098 contains a 3m tower tube.